

TRUCK STORAGE EQUIPMENT



THE ULTIMATE IN PROTECTION



WHAT DO THE MOST ADMIRABLE TRADESMEN AND CONTRACTORS HAVE IN COMMON?



WEATHER GUARD® TRUCK EQUIPMENT



YOU KNOW THE ONES. Just like you, they understand that being at the top goes beyond skill and talent. It's about projecting competence every step of the way. It starts with buying the best possible truck. From there, it's all about fitting it with the stylish, organized security of WEATHER GUARD® Truck Boxes, Ladder Racks, Cab Protectors and In-Bed Storage Solutions. WEATHER GUARD® Truck Equipment. *The Ultimate in Protection.*



THE DEFENDER SERIES is an affordable line of truck boxes built with the professional grade durability, security, and weather resistance you expect from the WEATHER GUARD® brand.



WWW.WEATHERGUARD.COM

TABLE OF CONTENTS

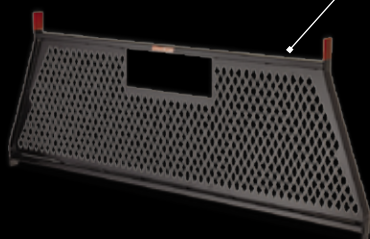

WEATHER GUARD® TRUCK BOXES.	4
▪ Saddle Boxes	4
▪ Cross Boxes	6
▪ Pork Chop Boxes	7
▪ All-Purpose Chests	8
▪ Lo-Side Boxes	10
▪ Hi-Side Boxes	12
▪ Super-Side Boxes	14
▪ Truck Box Accessories	15
▪ Gear Up™ Truck Fit Guide	16
DEFENDER SERIES™	18
▪ Saddle Boxes	19
▪ Side Boxes/Universal Chests	20
▪ Truck Fit Guide	21
UNDERBED BOXES	22
▪ Steel Underbed Boxes	22
▪ Aluminum Underbed Boxes	23
IN-BED STORAGE SOLUTIONS	24
▪ PACK RAT® Drawer Units	24
▪ BED RAT® Sliding Platform	27
▪ Transfer Tanks/Accessories	28
BED-MOUNTED SOLUTIONS	30
▪ Steel Truck Rack	30
▪ ATR® – Aluminum Truck Racks	32
▪ Service Body Ladder Racks	33
▪ WEEKENDER® Truck Rack	34
▪ PROTECT-A-RAIL® Cab Protectors/ Mounting Accessories	35
▪ Truck Rack Upfit Guide	37
CONFIGURATIONS GUIDE.	38
REPLACEMENT PARTS	39



LIMITED LIFETIME WARRANTY

WEATHER GUARD® IS THE ULTIMATE IN PROTECTION OF SADDLE BOXES

Like you, WEATHER GUARD® Saddle Boxes keep getting better and better. Now with more options and features than ever. Like industry-leading security with our exclusive tamper-resistant EXTREME PROTECTION™ LOCK. WEATHER GUARD® Saddle Boxes are the most popular truck storage option due to ease of installation, maximum bed clearance, and of course legendary durability. Constructed of either steel or aluminum diamond plate and finished with an ARMOR TUF® Powder Coat in Clear, Brite White, Gloss Black, or Textured Black that lasts for years and looks great.

ALUMINUM DIAMOND PLATE



Brite White
ARMOR TUF®
Powder Coat



Clear ARMOR TUF®
Powder Coat



Gloss Black
ARMOR TUF®
Powder Coat



Textured Black
ARMOR TUF®
Powder Coat

STEEL



Brite White
ARMOR TUF®
Powder Coat



Gloss Black
ARMOR TUF®
Powder Coat

Choice Options: X = 0 (Clear) or X = 3 (Brite White) or X = 5 (Gloss Black) or X = 52 (Textured Black)

THE ULTIMATE IN PROTECTION

Maximum Durability

- 1 ARMOR TUF® Powder Coat Protection
- 2 Heavy Gauge Five Piece Welded Construction puts strength where it is needed most
- 3 Welded Gas Strut Shields Aluminum shield protects gas strut from damage

Extreme Security

- 4 EXTREME PROTECTION™ LOCK tamper-resistant retracting lock helps protect against break-ins
- 5 Dual Stage Automotive Rotary Latch and Heavy Duty Looped Strikers provide extreme security
- 6 Heavy Duty C-Channel Reinforced Lid Construction and Lid Overlap Aluminum C-Channels welded into lid provide added pry resistance

Ultimate Weather Resistance

- 7 Automotive D-Shaped Ribbed Rubber Weather Stripping keeps its shape even after years of service
- 8 Lid Cover Overlap prevents direct water intrusion

INTEGRATED FEATURES

Convenient attachment points secures materials and tools in pickup bed

Sliding Steel Tray

Removable Parts Bin

THE ULTIMATE IN PROTECTION

SADDLE BOXES



FULL-SIZE STANDARD

11.3 CUBIC FEET

ALUMINUM

127-0-02 127-52-02

127-5-02

Ship Weight: 86 Lbs.

STEEL

126-3-02

126-5-02

Ship Weight: 133 Lbs.



FULL-SIZE EXTRA WIDE

15.3 CUBIC FEET

ALUMINUM

117-0-02 117-52-02

117-5-02

Ship Weight: 105 Lbs.

STEEL

116-3-02

116-5-02

Ship Weight: 160 Lbs.

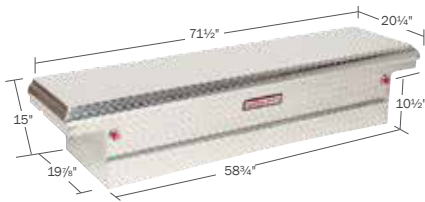

FULL-SIZE LOW PROFILE

8.8 CUBIC FEET

ALUMINUM

121-0-01 121-52-01

121-5-01

Ship Weight: 122 Lbs.

STEEL

120-3-01

120-5-01

Ship Weight: 122 Lbs.

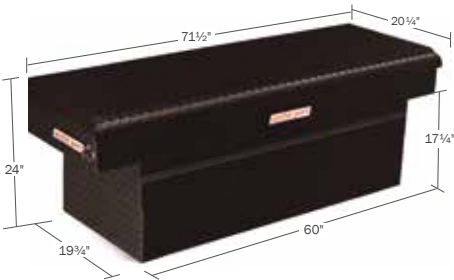

FULL-SIZE EXTRA DEEP

15.1 CUBIC FEET

ALUMINUM

123-0-01

123-5-01

Ship Weight: 94 Lbs.

STEEL

128-3-01

Ship Weight: 148 Lbs.



COMPACT STANDARD

6.4 CUBIC FEET

NOTE: This product has different dimensions for ALUMINUM and STEEL.

ALUMINUM

154-0-01

154-5-01

Ship Weight: 68 Lbs.

STEEL

156-3-01

Ship Weight: 100 Lbs.



COMPACT LOW-PROFILE

8.7 CUBIC FEET

ALUMINUM

131-0-01

131-5-01

Ship Weight: 76 Lbs.



COMPACT DEEP

8.9 CUBIC FEET

ALUMINUM

137-0-01

137-5-01

Ship Weight: 79 Lbs.

STEEL

136-3-01

Ship Weight: 115 Lbs.

THE ULTIMATE IN PROTECTION

CROSS BOXES



CROSS BOX KEY FEATURES

- 1 **EXTREME PROTECTION™ LOCK** tamper-resistant retracting lock helps protect against break-ins
- 2 **Two independent covers** access from either side of truck
- 3 **Dual Stage Automotive Rotary Latch and Heavy Duty Looped Strikers** provide extreme security
- 4 **Heavy Duty C-Channel Reinforced Lid Construction** for maximum durability
- 5 **Automotive D-Shaped Ribbed Rubber Weather Stripping** keep its shape even after years of service
- 6 **ARMOR TUF® Powder Coat Protection**
- 7 **Heavy Gauge Five Piece Welded Construction** puts strength where it is needed most

LIMITED LIFETIME WARRANTY

QUICK ACCESS FROM EITHER SIDE OF THE TRUCK BED

WEATHER GUARD® Cross Boxes allow access from either side of the truck with two independent covers. A productivity-aiding plus is an automotive-style latch that allows you to pop each cover open with one hand. These rugged, versatile boxes are available in steel with a Brite White or Gloss Black ARMOR TUF® Powder Coat, or in aluminum diamond plate (Clear or Gloss Black) and a full weather seal keeps out the elements. Cross Boxes can be used in combination with Lo-Side or Super-Lo Boxes for even more storage.

FULL-SIZE STANDARD 11.3 CUBIC FEET

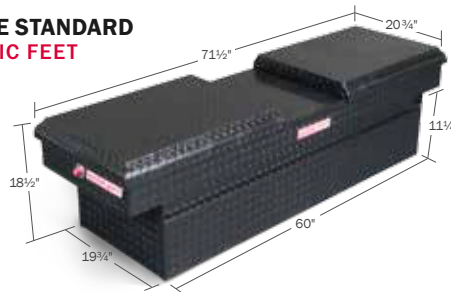

ALUMINUM

- 124-0-01
 - 124-5-01
- Ship Weight: 78 Lbs.

STEEL

- 125-3-01
 - 125-5-01
- Ship Weight: 122 Lbs.

FULL-SIZE EXTRA WIDE 15.3 CUBIC FEET



ALUMINUM

- 114-0-01
 - 114-5-01
- Ship Weight: 92 Lbs.

STEEL

- 115-3-01
- Ship Weight: 150 Lbs.

PORK CHOP BOXES

PORK CHOP BOX KEY FEATURES

- 1 **EXTREME PROTECTION™ LOCK**
tamper-resistant retracting lock helps protect against break-ins
- 2 **90° Cover opening**
for easy access
- 3 **Heavy Duty C-Channel Reinforced Lid Construction**
for maximum durability
- 4 **Automotive D-Shaped Ribbed Rubber Weather Stripping**
keeps its shape even after years of service
- 5 **ARMOR TUF® Powder Coat Protection**



LIMITED LIFETIME WARRANTY

DRIVER/PASSENGER-SIDE STANDARD 2.1 CUBIC FEET

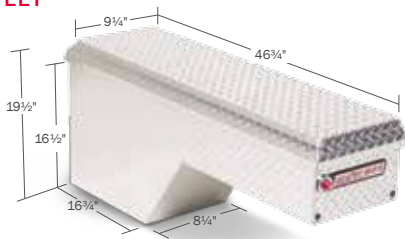

ALUMINUM

- 170-0-01 (driver)
- 171-0-01 (passenger)

- 170-5-01 (driver)
- 171-5-01 (passenger)

Ship Weight: 36 Lbs.

STEEL

- 160-3-01 (driver)
- 161-3-01 (passenger)

Ship Weight: 53 Lbs.

DRIVER/PASSENGER-SIDE WIDE 3.4 CUBIC FEET

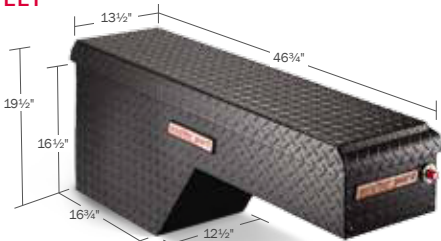

ALUMINUM Ship Weight: 42 Lbs.

- 172-0-01 (driver)
- 173-0-01 (passenger)

- 172-5-01 (driver)
- 173-5-01 (passenger)

Ship Weight: 66 Lbs.

- #### STEEL
- 162-3-01 (driver)
 - 163-3-01 (passenger)

MAKING USE OF SPACE AROUND THE WHEEL WELLS

WEATHER GUARD® has figured out a way to make use of otherwise unutilized truck bed space above and behind the wheel wells with these uniquely shaped boxes. They establish a great location for storing small parts and hand tools to which you often need quick, easy access. They're constructed of either steel—protected with a Brite White ARMOR TUF® Powder Coat finish—or aluminum diamond plate (Clear or Gloss Black). Pork Chop Boxes leave plenty of room in the truck bed for hauling around your weekend toys.

THE ULTIMATE IN PROTECTION

ALL PURPOSE CHESTS



ALL PURPOSE CHESTS KEY FEATURES

- 1 **EXTREME PROTECTION™ LOCK**
tamper-resistant retracting lock helps protect against break-ins
- 2 **90° Cover opening** for easy access
- 3 **Heavy Duty C-Channel Reinforced Lid Construction**
for maximum durability
- 4 **Dual Stage Automotive Rotary Latch and Heavy Duty Looped Strikers** provide extreme security
- 5 **Unique Offset Hinges** allows chest to lie flat against truck
- 6 **Automotive D-Shaped Ribbed Rubber Weather Stripping** keeps its shape even after years of service
- 7 **Sliding Steel Tray** all chests except compact

LIMITED LIFETIME WARRANTY

A LOW-RIDER WORK HORSE

Maximize your visibility with All-Purpose Chests that sit below the bedrail, accommodating tonneau covers and lids. An angled body design allows the chest to fit in fifth-wheel trailer configurations. The cover opens to 90° for maximum access using a unique offset hinge design that still allows installation flush against the truck cab. For durability, they're built of steel and finished with Brite White or Gloss Black ARMOR TUF® Powder Coat, or diamond plate aluminum (Clear, Brite White, Gloss Black, or Textured Black).

ALUMINUM DIAMOND PLATE



Brite White
ARMOR TUF®
Powder Coat



Clear ARMOR TUF®
Powder Coat



Gloss Black
ARMOR TUF®
Powder Coat



Textured Black
ARMOR TUF®
Powder Coat

STEEL



Brite White
ARMOR TUF®
Powder Coat





Gloss Black
ARMOR TUF®
Powder Coat

Choice Options: X = 0 (Clear) or X = 3 (Brite White) or X = 5 (Gloss Black) or X = 52 (Textured Black)

COMPACT
6.0 CUBIC FEET



ALUMINUM

-  644-0-01
 -  644-5-01
- Ship Weight: 37 Lbs.

STEEL

-  645-3-01
- Ship Weight: 67 Lbs.

FULL/COMPACT
10.0 CUBIC FEET



ALUMINUM

-  674-0-01
 -  674-5-01
 -  674-52-01
- Ship Weight: 43 Lbs.



STEEL

-  675-3-01
- Ship Weight: 80 Lbs.



FULL/COMPACT
12.0 CUBIC FEET



ALUMINUM

-  654-0-01
 -  654-5-01
- Ship Weight: 52 Lbs.

STEEL

-  655-3-01
 -  655-5-01
- Ship Weight: 94 Lbs.



FULL-SIZE STANDARD
13.1 CUBIC FEET



ALUMINUM

-  664-0-01
 -  664-5-01
 -  664-52-01
- Ship Weight: 57 Lbs.



STEEL

-  665-3-01
 -  665-5-01
- Ship Weight: 112 Lbs.

FULL-SIZE EXTRA WIDE
18.6 CUBIC FEET



ALUMINUM

-  684-0-01
 -  684-5-01
- Ship Weight: 71 Lbs.

STEEL

-  685-3-01
- Ship Weight: 134 Lbs.

THE ULTIMATE IN PROTECTION

LO-SIDE BOXES

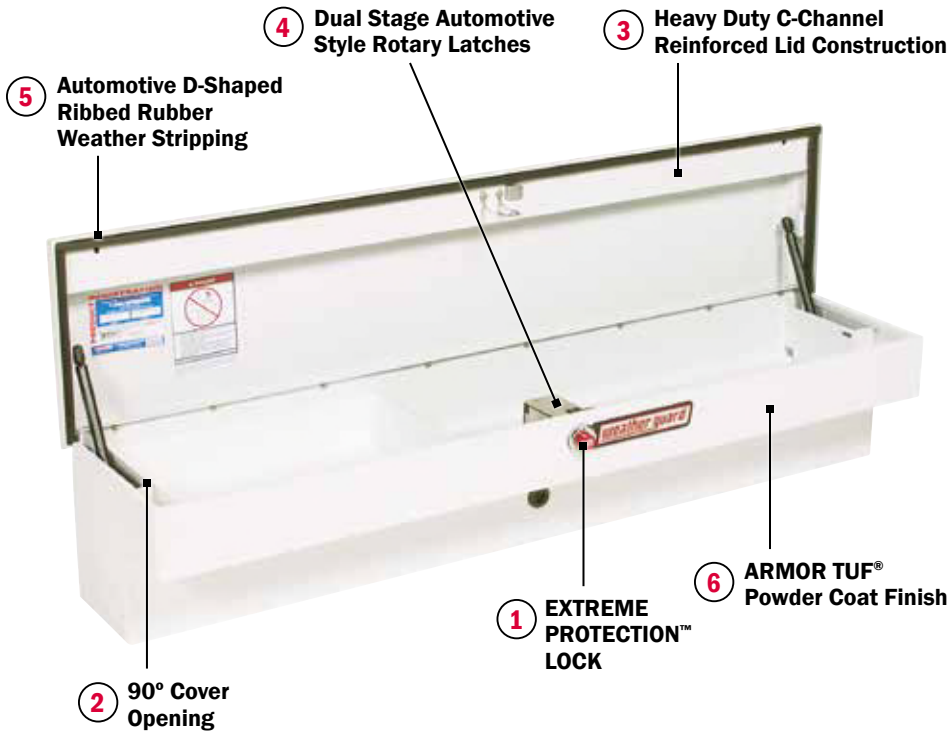

LO-SIDE BOXES KEY FEATURES

- 1** **EXTREME PROTECTION™ LOCK**
tamper-resistant retracting lock helps protect against break-ins
- 2** **90° Cover opening** for easy access
- 3** **Heavy Duty C-Channel Reinforced Lid Construction** for maximum durability
- 4** **Dual Stage Automotive Rotary Latch and Heavy Duty Looped Strikers** provide extreme security
- 5** **Automotive D-Shaped Ribbed Rubber Weather Stripping** keeps its shape even after years of service
- 6** **ARMOR TUF® Powder Coat Protection**

LIMITED LIFETIME WARRANTY

QUICK ACCESS FROM THE BEDRAILS

WEATHER GUARD® Lo-Side Boxes mount over the bedrails of your truck and keep critical tools and parts at your fingertips. Their easy installation utilizes mounting brackets that do not require drilling into the rails. The design and location on the truck bed aren't the only attributes that keep you productive—you can get inside with just one hand using an automotive-style latch. The durable Lo-Side is available in steel, and protected by an ARMOR TUF® Powder Coat finish in either Brite White or Gloss Black, or diamond plate aluminum (Clear, Brite White, Gloss Black, and Textured Black). The Lo-Side from WEATHER GUARD® can also be used separately or in combination with Cross Boxes or Saddle Boxes.

ALUMINUM DIAMOND PLATE



Brite White
ARMOR TUF®
Powder Coat



Clear ARMOR TUF®
Powder Coat



Gloss Black
ARMOR TUF®
Powder Coat



Textured Black
ARMOR TUF®
Powder Coat

STEEL



Brite White
ARMOR TUF®
Powder Coat



Gloss Black
ARMOR TUF®
Powder Coat

Choice Options: X = 0 (Clear) or X = 3 (Brite White) or X = 5 (Gloss Black) or X = 52 (Textured Black)

LO-SIDE-SHORT

ALUMINUM
STEEL

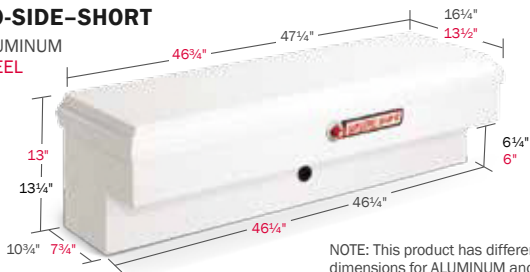

NOTE: This product has different dimensions for ALUMINUM and STEEL.

ALUMINUM 3.4 CUBIC FEET

- 184-3-01 184-0-01
- 184-5-01 184-52-01

Ship Weight: 46 Lbs.

STEEL 3.2 CUBIC FEET

- 185-3-01

Ship Weight: 63 Lbs.

LO-SIDE-STANDARD

ALUMINUM
STEEL

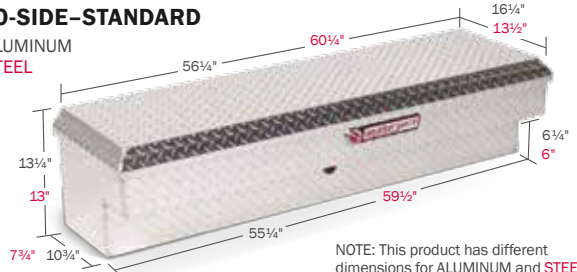

NOTE: This product has different dimensions for ALUMINUM and STEEL.

ALUMINUM 4.1 CUBIC FEET

- 174-0-01 174-52-01
- 174-5-01

Ship Weight: 53 Lbs.

STEEL 4.5 CUBIC FEET

- 175-3-01

Ship Weight: 81 Lbs.

LO-SIDE LONG

ALUMINUM
STEEL

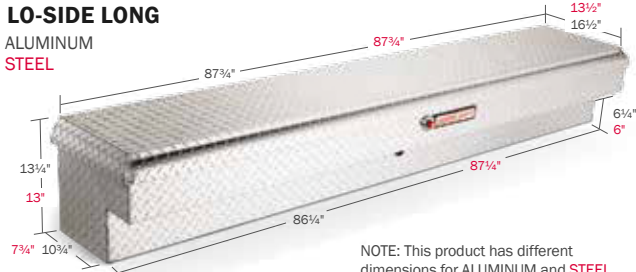

NOTE: This product has different dimensions for ALUMINUM and STEEL.

ALUMINUM 6.4 CUBIC FEET

- 164-0-01
- 164-5-01

Ship Weight: 74 Lbs.

STEEL 6.2 CUBIC FEET

- 165-3-01

Ship Weight: 108 Lbs.

LOW-PROFILE SIDE-SHORT
3.2 CUBIC FEET

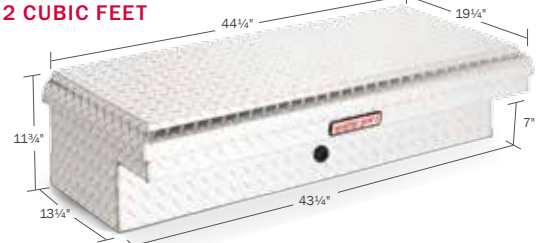

ALUMINUM

- 180-0-01 (DRIVER)
- 181-0-01 (PASSENGER)

Ship Weight: 41 Lbs.

ALUMINUM

- 180-5-01 (DRIVER)
- 181-5-01 (PASSENGER)

Ship Weight: 41 Lbs.

LOW-PROFILE SIDE-STANDARD
4.3 CUBIC FEET



ALUMINUM

- 178-0-01 (DRIVER)
- 179-0-01 (PASSENGER)

Ship Weight: 46 Lbs.

ALUMINUM

- 178-5-01 (DRIVER)
- 179-5-01 (PASSENGER)

Ship Weight: 46 Lbs.

SUPER-LO-SHORT
4.5 CUBIC FEET

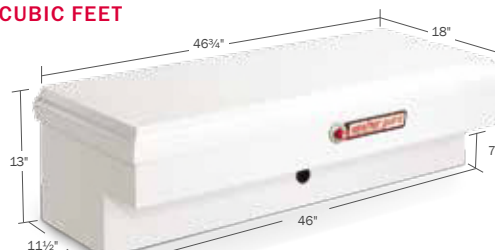

STEEL

- 186-3-01

Ship Weight: 72 Lbs.

SUPER-LO-STANDARD
6.5 CUBIC FEET



STEEL

- 176-3-01
- 176-5-01

Ship Weight: 94 Lbs.

SUPER-LO-LONG
9.2 CUBIC FEET



STEEL

- 166-3-01

Ship Weight: 128 Lbs.

THE ULTIMATE IN PROTECTION

HI-SIDE BOXES

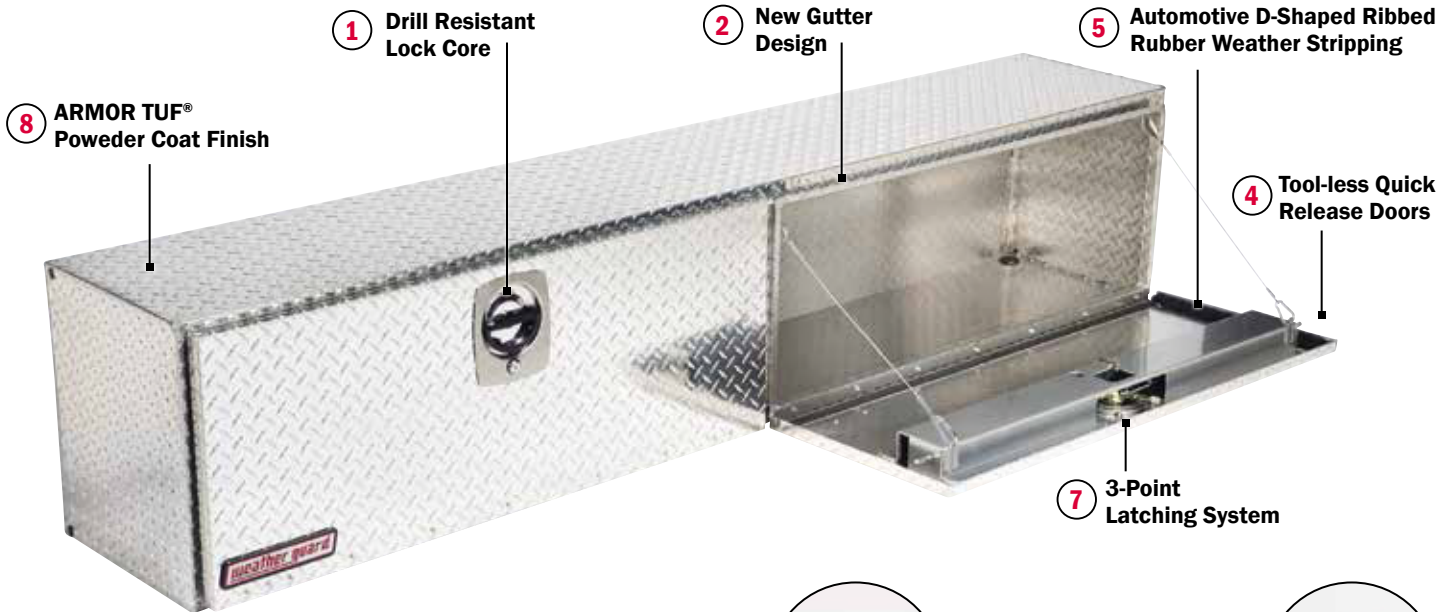

3 Removable Parts Bin



6 Convenient Attachment Points



LIMITED LIFETIME WARRANTY

ADDING STORAGE WHILE PRESERVING BED SPACE

Even the best can get better. That's why we keep pushing our engineers to top themselves. And so they have. Now our class-leading WEATHER GUARD® Hi-Side Truck Boxes deliver even greater protection. From the elements. From vandalism. WEATHER GUARD® Hi-Sides are built to outlast the competition, just like you—hard-working construction pros. Skilled tradespeople. Field service and municipal workers who need quick access to valuable tools, equipment and parts while keeping the truck bed open for supplies. You never stop. Neither do we.

WARNING

Hi-Side Boxes cannot be installed to truck racks. Support legs included with box is required for installation.

HI-SIDE 5.6 CUBIC FEET



ALUMINUM

- 346-0-02
 - 346-5-02
- Ship Weight: 45 Lbs.

STEEL

- 246-3-02
- Ship Weight: 76 Lbs.

Door Opening Measures:
12 3/4" H x 42" W

HI-SIDE 7.9 CUBIC FEET



ALUMINUM

- 364-0-02
 - 364-5-02
- Ship Weight: 60 Lbs.

STEEL

- 264-3-02
- Ship Weight: 101 Lbs.

Door Opening Measures:
12 3/4" H x 29" W

HI-SIDE BOXES KEY FEATURES

- 1 Drill resistant lock core helps protect against break-ins
- 2 Gutter design channels rain and snow off box to keep contents dry
- 3 Removable parts bin keeps small items organized
- 4 Tool-less quick release doors adjust from 90° to 180° with QuickClips, no tools required
- 5 Automotive D-Shaped Ribbed Rubber Weather Stripping keeps its shape even after years of service
- 6 Convenient attachment point secures materials and tools in pickup bed
- 7 3-Point Latching System helps protect against theft and weather
- 8 **ARMOR TUF®**
Powder Coat Protection

RECOMMENDED ACCESSORIES

Adjustable Shelf
Accessory (pg. 15)



Parts Cabinet
Accessory (pg. 15)



HI-SIDE
8.9 CUBIC FEET



ALUMINUM
372-0-02
372-5-02

Ship Weight: 64 Lbs.

Door Opening Measures:
12 3/4"H x 33"W

HI-SIDE
8.9 CUBIC FEET



STEEL
272-3-02

Ship Weight: 109 Lbs.

Door Opening Measures:
12 3/4"H x 33"W

HI-SIDE
11.1 CUBIC FEET



ALUMINUM
390-0-02
390-5-02

Ship Weight: 74 Lbs.

Door Opening Measures:
12 3/4"H x 42"W

HI-SIDE
11.1 CUBIC FEET



STEEL
290-3-02

Ship Weight: 129 Lbs.

Door Opening Measures:
12 3/4"H x 42"W

HI-SIDE
11.8 CUBIC FEET



ALUMINUM
396-0-02
396-5-02

Ship Weight: 79 Lbs.

Door Opening Measures:
12 3/4"H x 45"W

HI-SIDE
11.8 CUBIC FEET



STEEL
296-3-02

Ship Weight: 136 Lbs.

Door Opening Measures:
12 3/4"H x 45"W

THE ULTIMATE IN PROTECTION

SUPER-SIDE BOXES

SUPER-SIZE YOUR STORAGE

Super-Side versions of the WEATHER GUARD® Hi-Side are available—whether you choose the steel or diamond plate aluminum version—with all of the same features that the Hi-Sides offer. A Super-Side version of the steel Hi-Side is available, providing an extra 2 inches of height and 3 inches of depth. A Jumbo Super-Side version of the steel Hi-Side is also available, with 6 more inches of width and 6 more inches of height for a whopping 21.4 cubic feet capacity. An extra-large Super-Side version of the aluminum Hi-Side is available, too, with an extra 2 inches of height and 3 inches of depth.

LIMITED LIFETIME WARRANTY

ALUMINUM DIAMOND PLATE

 Brite White ARMOR TUF® Powder Coat

 Gloss Black ARMOR TUF® Powder Coat

 Clear ARMOR TUF® Powder Coat

 Textured Black ARMOR TUF® Powder Coat

STEEL

 Brite White ARMOR TUF® Powder Coat

 Gloss Black ARMOR TUF® Powder Coat

Choice Options:

- X = 0 (Clear) or
- X = 3 (Brite White) or
- X = 5 (Gloss Black) or
- X = 52 (Textured Black)

SUPER-SIDE 7.7 CUBIC FEET



ALUMINUM

 347-0-02

 347-5-02

Ship Weight: 50 Lbs.

STEEL

 247-3-02

Ship Weight: 86 Lbs.

Door Opening Measures:
14 3/4" H x 42" W

SUPER-SIDE 10.8 CUBIC FEET



ALUMINUM

 365-0-02

 365-5-02

Ship Weight: 65 Lbs.

STEEL

 265-3-02

Ship Weight: 114 Lbs.

Door Opening Measures:
14 3/4" H x 29" W

SUPER-SIDE 15.2 CUBIC FEET



ALUMINUM

 391-0-02

 391-5-02

 391-52-02

Ship Weight: 83 Lbs.

STEEL

 291-3-02

Ship Weight: 147 Lbs.

Door Opening Measures:
14 3/4" H x 42" W

JUMBO SUPER-SIDE 21.4 CUBIC FEET



STEEL

 297-3-02

Ship Weight: 174 Lbs.

Door Opening Measures:
20 3/4" H x 45" W

TRUCK BOX ACCESSORIES

KEEP YOUR TOOLS AND EQUIPMENT ORGANIZED AND EASY TO ACCESS

ACCESSORY TOOL BOX

610 – Plastic Tool Box
Ship Weight: 3 Lbs.



ACCESSORY PARTS BIN FOR SADDLE BOXES

618 – Accessory Parts Box
Ship Weight: 2 Lbs.

NEW WEATHER GUARD® Parts Box fits into enhanced (-02) Saddle Boxes.

FITS: 116-X-02, 117-X-02, 126-X-02 and 127-X-02

ACCESSORY TRAY FOR LO-SIDE & SUPER-LO BOXES

911 – Tray
Ship Weight: 9 Lbs.



STEEL DIVIDER TRAY

613-3 – 19¼" L x 14" W
Ship Weight: 14 Lbs.

FITS: 124-X-01, 125-X-01, 126-X-02, 127-X-02, 137-X-01, 154-X-01, 156-X-01, 654-X-01, 664-X-01, 665-X-01, 674-X-01, 675-X-01



STEEL DIVIDER TRAY

614-3 – 26½" L x 14⅞" W
Ship Weight: 14 Lbs.

FITS: 114-X-01, 115-X-01, 116-X-02, 117-X-02, 684-X-01, 685-X-01



STEEL DIVIDER TRAY

615 – 19¼" L x 14" W
Ship Weight: 14 Lbs.

FITS: 121-X-01, 123-X-01, 124-X-01, 126-X-02, 127-X-02, 128-X-01, 131-X-01, 136-X-01, 137-X-01, 154-X-01, 156-X-01, 654-X-01, 655-X-01, 664-X-01, 665-X-01, 674-X-01, 675-X-01



STEEL DIVIDER TRAY

617 – 26½" L x 14" W
Ship Weight: 14 Lbs.

FITS: 114-X-01, 115-X-01, 116-X-02, 117-X-02, 684-X-01, 685-X-01



STEEL TOTE TRAY

619-3 – 18½" L x 9" W x 3" H
Ship Weight: 8 Lbs.

FITS: 126-X-02, 127-X-02, 136-X-01, 154-X-01, 156-X-01



STEEL TOTE TRAY

620-3 – 25½" L x 9" W x 3" H
Ship Weight: 14 Lbs.

FITS: 116-X-02, 117-X-02



TRAYS

200-3 – 41½" L x 9½" W
Ship Weight: 17 Lbs.

202-3 – 24" L x 9½" W
Ship Weight: 12 Lbs.

16-gauge steel with adjustable dividers; bolts to back wall of cabinet.



Shown in Hi-Side Box

PARTS CABINET

201-3 – 32½" L x 11¾" H
Ship Weight: 28 Lbs.

All steel cabinets feature removable partitions; bolts through bottom of box. Not intended for use with 264-X-02 and 272-X-02.



Shown in Hi-Side Box

WATCHMAN® IV SINGLE-PADLOCK LOCK SYSTEM

9036-3
Ship Weight: 93 Lbs.

FOR INSIDE USE ONLY! Use in conjunction with a pickup cap or other type of enclosure and bolt it to the truck bed.



GEAR UP™ TRUCK FIT GUIDE

Aluminum Boxes available in Brite White, Clear or Gloss Black ARMOR TUF® Powder Coat.

Steel Boxes available in Brite White and Textured Black ARMOR TUF® Powder Coat.

Coating Choice Options: **X=0** (Clear) or **X=3** (Brite White) or **X=5** (Gloss Black) or **X=52** (Textured Black).

Not all coating choices available on all models.

		ALUMINUM	STEEL	5' FLEETSIDE	6' FLEETSIDE	5½ FLEETSIDE	6' FLEETSIDE	8' FLEETSIDE	5' BED	6½' BED	57" BED	6' BED	8' BED	6' STYLESIDE	7' STYLESIDE
SADDLE BOXES				CHEVROLET COLORADO	CHEVROLET SILVERADO*			DODGE DAKOTA		DODGE RAM			FORD RANGER		
FULL-SIZE EXTRA WIDE		116-X-02					•	•			•	•	•		
		117-X-02					•	•			•	•	•		
FULL-SIZE EXTRA DEEP		128-X-01					•	•					•		
		123-X-01					•	•					•		
FULL-SIZE STANDARD		126-X-02					•	•			•	•	•		
		127-X-02					•	•			•	•	•		
FULL-SIZE LOW-PROFILE		120-X-01			•	•	•				•	•	•		
		121-X-01			•	•	•				•	•	•		
COMPACT - DEEP		136-3-01	•	•					•	•				•	•
		137-X-01			•	•			•	•				•	•
COMPACT - STANDARD		156-X-01	•	•					•	•				•	•
		154-X-01			•	•			•	•				•	•
COMPACT - LOW-PROFILE		131-X-01			•	•			•	•				•	•
CROSS BOXES															
FULL-SIZE EXTRA WIDE		115-3-01					•	•			•	•	•		
		114-X-01					•	•			•	•	•		
FULL-SIZE STANDARD		125-X-01			•	•	•				•	•	•		
		124-X-01			•	•	•				•	•	•		
ALL-PURPOSE CHESTS															
COMPACT		645-X-01	•	•	•	•	•	•	•	•	•	•	•	•	•
		644-X-01	•	•	•	•	•	•	•	•	•	•	•	•	•
FULL/COMPACT		655-3-01				•	•			•			•		
		654-X-01				•	•			•			•		
FULL-SIZE STANDARD		655-X-01				•	•						•		
		664-X-01				•	•						•		
FULL/COMPACT		675-3-01			•	•	•			•	•	•	•	•	•
		674-X-01			•	•	•			•	•	•	•	•	•
FULL-SIZE EXTRA WIDE		685-3-01					•						•		
		684-X-01					•						•		

* Newer truck models available with aluminum beds are compatible with the WEATHER GUARD® truck boxes and chests in the table. Follow installation instructions for mounting to aluminum beds and use mounting components included with the truck box.

NOTE: THIS GUIDE APPLIES TO 2005 AND NEWER MODEL YEAR VEHICLES.
 YOU SHOULD MEASURE YOUR VEHICLE TO MAKE SURE YOUR WEATHER GUARD® TRUCK BOX WILL FIT.

5½' STYLESIDE		6½' STYLESIDE		6½' FLARESIDE		8' STYLESIDE		6½' STYLESIDE		8' STYLESIDE		5' FLEETSIDE		6' FLEETSIDE		5½' FLEETSIDE		6' FLEETSIDE		8' FLEETSIDE		5' BED		6' BED		6' BED		8' BED		4½' BED		6' BED		5½' BED		6½' BED	
FORD F150*						FORD F250*						GMC CANYON		GMC SIERRA*				TOYOTA TACOMA		TOYOTA TUNDRA				NISSAN FRONTIER				NISSAN TITAN									
•	•		•	•	•					•	•					•	•					•										•	•				
•	•		•	•	•					•	•					•	•					•										•	•				
			•		•					•	•					•	•					•											•				
			•		•					•	•					•	•					•												•			
•	•		•	•	•					•	•					•	•					•											•	•			
•	•		•	•	•					•	•					•	•					•											•	•			
•	•	•	•	•	•							•				•	•					•											•	•			
										•	•											•	•						•	•							
										•	•											•	•														
										•	•											•	•														
										•	•											•	•														

•	•		•	•	•					•	•											•									•	•	
•	•		•	•	•					•	•											•										•	•
•	•		•	•	•					•	•											•										•	•
•	•		•	•	•					•	•											•										•	•

•	•	•	•	•	•	•	•	•	•	•					•	•	•	•	•	•	•	•	•	•	•	•	•	•	•	•	•	•	•	•	•		
•	•	•	•	•	•	•	•	•	•	•					•	•	•	•	•	•	•	•	•	•	•	•	•	•	•	•	•	•	•	•	•	•	
			•	•	•					•	•											•															
			•	•	•					•	•											•															
			•	•	•					•	•											•															
•	•	•	•	•	•							•										•															
•	•	•	•	•	•							•										•															
			•																			•															
			•																			•															

weather guard®

DEFENDER SERIES™

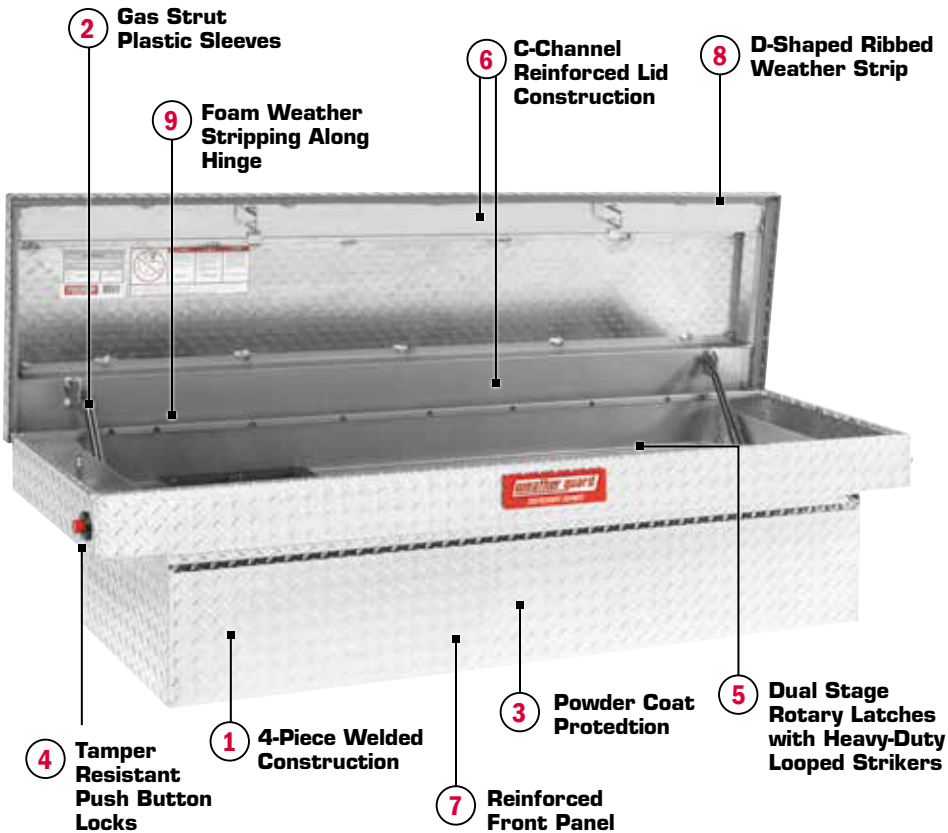

PROFESSIONAL GRADE PROTECTION

PROFESSIONAL DURABILITY

- 1 **4-Piece Welded Construction**
Puts more strength where it is needed most
- 2 **Gas Strut Plastic Sleeves**
Prevents basic damage from sliding materials in the box
- 3 **Powder Coat Protection**
Available in Black

HEAVY DUTY SECURITY

- 4 **Tamper Resistant Push Button Locks**
Drill resistant through key hole
- 5 **Two Dual Stage Rotary Latches with Heavy-Duty Looped Strikers**
Secures lid closed and resists pry-in
Looped Striker with steel reinforcement is bolted to heavy-duty C-channel
- 6 **C-Channel Reinforced Lid Construction**
Heavy-duty aluminum welded into lid resists pry-ins
- 7 **Reinforced Front Panel**
Rigid front panel resists pry-in

CLASSIC WEATHER RESISTANCE

- 8 **D-Shaped Ribbed weather strip**
- 9 **Foam Weather Stripping along hinge completes 4 sided weather resistance**

INTEGRATED FEATURES

- Plastic Parts Sliding Tray
- No-Crimp/No-Drill Mounting Hardware
- Built-in Side Compartments

7 YEAR WARRANTY

INTRODUCING THE DEFENDER SERIES™

a new affordable line of truck boxes built with the professional grade durability, security, and weather resistance you expect from the WEATHER GUARD® brand. Now there is a WEATHER GUARD® for every truck and user out there.

ALUMINUM DIAMOND PLATE



Uncoated



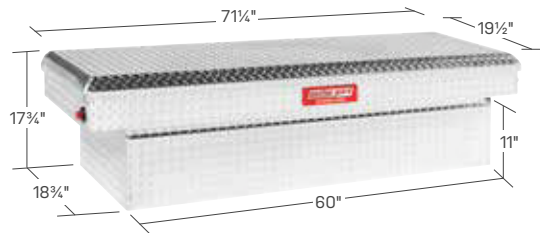

Black Powder Coat

PROFESSIONAL GRADE PROTECTION
SADDLE BOXES/CROSS BOXES





**FULL SIZE TRUCK
 STANDARD SADDLE**
10.7 CUBIC FEET

-  300105-9-01
-  300105-53-01

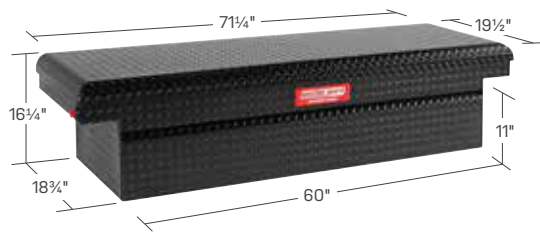
*Approximate
 Ship Weight: 56 lbs*





**FULL SIZE TRUCK
 LOW PROFILE SADDLE**
9.5 CUBIC FEET

-  300106-9-01
-  300106-53-01

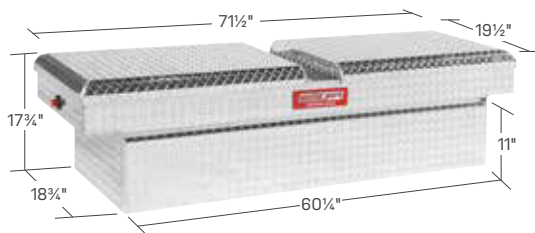
*Approximate
 Ship Weight: 56 lbs*





**FULL SIZE TRUCK
 STANDARD CROSS**
10.2 CUBIC FEET

-  300207-9-01
-  300207-53-01

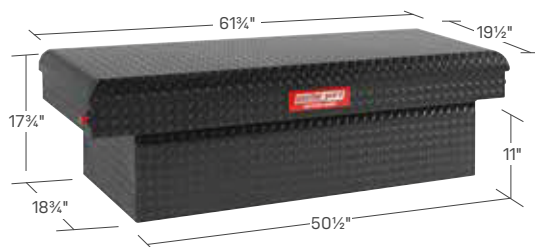
*Approximate
 Ship Weight: 56 lbs*



**COMPACT TRUCK
 STANDARD SADDLE**
9 CUBIC FEET

-  300104-9-01
-  300104-53-01



*Approximate
 Ship Weight: 56 lbs*

PROFESSIONAL GRADE PROTECTION

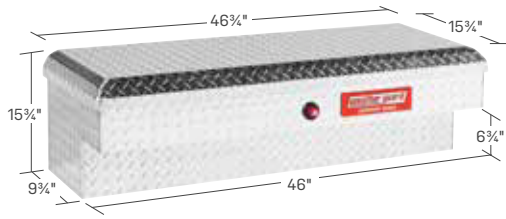
SIDE BOXES/UNIVERSAL CHESTS





48" SHORT LO-SIDE
12.5 CUBIC FEET

-  300304-9-01
-  300304-53-01

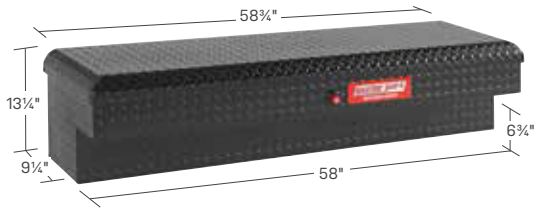
Approximate Ship Weight: 39 lbs





60" STANDARD LO-SIDE
9.3 CUBIC FEET

-  300300-9-01
-  300300-53-01

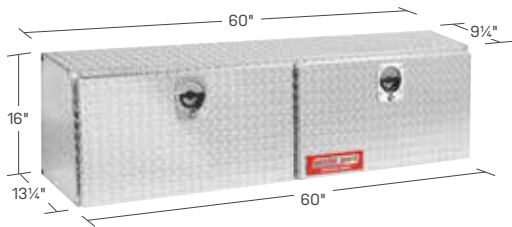
Approximate Ship Weight: 47 lbs





60" HI-SIDE BOXES
3.3 CUBIC FEET

-  300302-9-01
-  300302-53-01

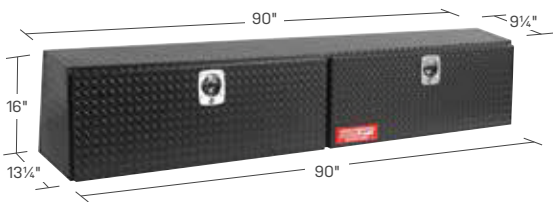
Approximate Ship Weight: 45 lbs





90" HI-SIDE BOXES
9 CUBIC FEET

-  300303-9-01
-  300303-53-01

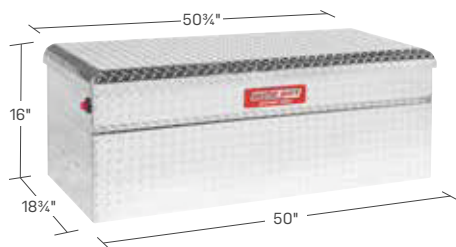
Approximate Ship Weight: 57 lbs





50" UNIVERSAL CHEST
18.8 CUBIC FEET

-  300401-9-01
-  300401-53-01



Approximate Ship Weight: 46 lbs

ALSO AVAILABLE



72" LONG LO-SIDE
5.3 CUBIC FEET

-  300301-9-01
-  300301-53-01

36" UNDERBED
7.1 CUBIC FEET

-  300500-9-01
-  300500-53-01

48" UNDERBED
9.5 CUBIC FEET

-  300501-9-01
-  300501-53-01

DEFENDER SERIES™ TRUCK FIT GUIDE

STEP 1 Determine Your Vehicle Type

COMPACT TRUCK	FULL SIZE TRUCK		
COMPACT BED	SHORT BED	STANDARD BED	LONG BED
5-½' (66") or 6-½' (78")	5-½' (66")	6-½' (78")	8' (96")

STEP 2 Choose a Saddle Box, Cross Box, or Universal Chest

COMPACT TRUCK	FULL SIZE TRUCK		
COMPACT BED	SHORT BED	STANDARD BED	LONG BED
Compact Standard 20"w 300104-XX-01	Full Size Standard 20"w 300105-XX-01	Full Size Standard 20"w 300105-XX-01	Full Size Standard 20"w 300105-XX-01
	Full Size Low Profile 20"w 300106-XX-01	Full Size Low Profile 20"w 300106-XX-01	Full Size Low Profile 20"w 300106-XX-01
	Full Size Cross Box 20"w 300207-XX-01	Full Size Cross Box 20"w 300207-XX-01	Full Size Cross Box 20"w 300207-XX-01
	Universal Chest 19.5"w 300401-XX-01	Universal Chest 19.5"w 300401-XX-01	Universal Chest 19.5"w 300401-XX-01

STEP 3 Choose Color



Uncoated
300XXX-9-01



Powder Coated Black
300XXX-53-01

STEP 4 Add Side Boxes in Combination with Saddle/Cross Boxes

Determine remaining bed rail length on vehicle and choose front end following.
Include 3" of buffer space for box spacing, tail gate clearance, and lid clearance.

COMPACT TRUCK		FULL SIZE TRUCK					
COMPACT BED		SHORT BED		STANDARD BED		LONG BED	
Low-Side Combo	High-Side Combo	Low-Side Combo	High-Side Combo	Low-Side Combo	High-Side Combo	Low-Side Combo	High-Side Combo
48" Only 300304-XX-01	N/A	Combo of Saddle/Cross & Side Box Not Available		48" Only 300304-XX-01	N/A	48", 60", 72" 300304-XX-01 300300-XX-01 300301-XX-01	60" 300302-XX-01
Side Boxes Only		Side Boxes Only		Side Boxes Only		Side Boxes Only	
48", 60", 72" 300304-XX-01 300300-XX-01 300301-XX-01	60" Only 300302-XX-01	48", 60" 300304-XX-01 300300-XX-01	60" 300302-XX-01	48", 60", 72" 300304-XX-01 300300-XX-01 300301-XX-01	N/A	48", 60" 72" 300304-XX-01 300300-XX-01 300301-XX-01	60", 90" 300302-XX-01 300303-XX-01

THE ULTIMATE IN PROTECTION

STEEL UNDERBED BOXES



STEEL UNDERBED BOX KEY FEATURES

- 1 Gutter design & weather stripping easy and positive door closure that protects against the elements
- 2 3-point latching system for optimum security and weather resistance
- 3 Stainless Steel D Handle for easy and positive door closure, and added protection against break-ins
- 4 Tool-less quick release drop down door full and easy access, adjusts from 90° to 180°
- 5 Automotive D-Shaped Ribbed Rubber Weather Stripping keeps its shape even after years of service
- 6 ARMOR TUF® Powder Coat Protection

WIDE SELECTION OF SIZES FOR YOUR NEEDS

WEATHER GUARD® Steel Underbed Boxes come in three size groupings: compact, standard and jumbo. A Brite White or Gloss Black ARMOR TUF® Powder Coat enhances the durability of these boxes' heavy-gauge steel. Steel Underbed Boxes are supplied with an aluminum door and hinge for superior resistance to rust and corrosion.

LIMITED LIFETIME WARRANTY

COMPACT UNDERBED



2.3 CUBIC FEET

- 525-3-02
 - 525-5-02
- Ship Weight: 45 Lbs.
Door Opening Measures: 10 1/2"H × 22 1/2"W

STANDARD UNDERBED



4.5 CUBIC FEET

- 524-3-02
 - 524-5-02
- Ship Weight: 45 Lbs.
(24 1/8"L × 18 1/4"W × 18 1/8"H)
Door Opening Measures: 14 1/2"H × 22 1/2"W

5.6 CUBIC FEET

- 530-3-02
 - 530-5-02
- Ship Weight: 70 Lbs.
(30 1/8"L × 18 1/4"W × 18 1/8"H)
Door Opening Measures: 14 1/2"H × 28 1/2"W

6.7 CUBIC FEET

- 536-3-02
 - 536-5-02 (Shown)
- Ship Weight: 82 Lbs.
Door Opening Measures: 14 1/2"H × 34 1/4"W

9.1 CUBIC FEET

- 548-3-02
 - 548-5-02
- Ship Weight: 100 Lbs.
(48 1/8"L × 18 1/4"W × 18 1/8"H)
Door Opening Measures: 14 1/2"H × 46 1/4"W

11.2 CUBIC FEET

- 560-3-02
 - 560-5-02
- Ship Weight: 135 Lbs.
(60 1/8"L × 18 1/4"W × 18 1/8"H)
Door Opening Measures: 14 1/2"H × 58 1/4"W

JUMBO UNDERBED



12.1 CUBIC FEET

- 538-3-02 (Shown)
 - 538-5-02
- Ship Weight: 111 Lbs.
(36 1/8"L × 24 1/4"W × 24 1/8"H)
Door Opening Measures: 20 1/2"H × 34 1/4"W

16.2 CUBIC FEET

- 550-3-02
 - 550-5-02
- Ship Weight: 145 Lbs.
(48 1/8"L × 24 1/4"W × 24 1/8"H)
Door Opening Measures: 20 1/2"H × 46 1/4"W

20.2 CUBIC FEET

- 562-5-02
- Ship Weight: 181 Lbs.
(60 1/8"L × 24 1/4"W × 24 1/8"H)
Door Opening Measures: 20 1/2"H × 58 1/4"W

ALUMINUM UNDERBED BOXES

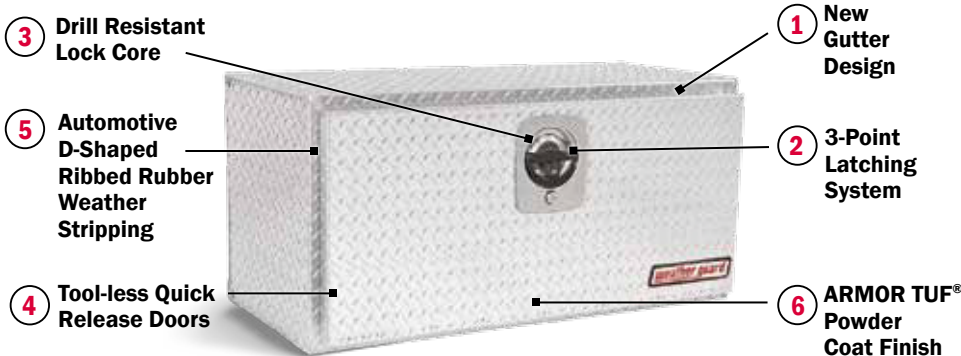

DURABILITY AT LIGHTER WEIGHT

WEATHER GUARD® Aluminum Underbed Boxes are available in compact, standard and jumbo versions to meet your specific needs. Clear or Gloss Black ARMOR TUF® Powder Coat finishes extend the ruggedness of the diamond plate aluminum.



TOOL-LESS QUICK RELEASE DROP DOWN DOOR



WEATHER STRIPPING protects contents from the weather.



STAINLESS STEEL D HANDLE With Drill-resistant Lock Core

LIMITED LIFETIME WARRANTY

ALUMINUM UNDERBED BOX KEY FEATURES

- 1** Gutter design & weather stripping easy and positive door closure that protects against the elements
- 2** 3-point latching system for optimum security and weather resistance
- 3** Stainless Steel D Handle for easy and positive door closure, and added protection against break-ins
- 4** Tool-less quick release drop down door full and easy access, adjusts from 90° to 180°
- 5** Automotive D-Shaped Ribbed Rubber Weather Stripping keeps its shape even after years of service
- 6** ARMOR TUF® Powder Coat Protection

COMPACT UNDERBED



2.4 CUBIC FEET

- 622-0-02
- 622-5-02

Ship Weight: 24 Lbs.
Door Opening Measures:
9 1/4"H x 19 1/4"W

STANDARD UNDERBED



4.3 CUBIC FEET

- 627-0-02

Ship Weight: 35 Lbs.
(24 1/8"L x 18 1/4"W x 18"H)
Door Opening Measures:
13 1/2"H x 19 1/4"W

5.4 CUBIC FEET

- 631-0-02
- 631-5-02

Ship Weight: 42 Lbs.
(30 1/8"L x 18"W x 18"H)
Door Opening Measures:
13 1/2"H x 25 1/4"W

6.5 CUBIC FEET

- 636-0-02 (Shown)
- 636-5-02

Ship Weight: 47 Lbs.
(36 1/8"L x 18"W x 18"H)
Door Opening Measures:
13 1/2"H x 34 1/4"W

8.6 CUBIC FEET

- 648-0-02

Ship Weight: 62 Lbs.
(48 1/8"L x 18"W x 18"H)
Door Opening Measures:
13 1/2"H x 43 1/4"W

11.2 CUBIC FEET

- 660-0-02
- 660-5-02

Ship Weight: 135 Lbs.
(60 1/8"L x 18"W x 18"H)
Door Opening Measures:
13 1/2"H x 55 1/4"W

JUMBO UNDERBED



12.2 CUBIC FEET

- 638-0-02

Ship Weight: 65 Lbs.
(36 1/8"L x 24"W x 24"H)
Door Opening Measures:
19 1/2"H x 31 1/4"W

16 CUBIC FEET

- 650-0-02

Ship Weight: 81 Lbs.
(48 1/8"L x 24"W x 24"H)
Door Opening Measures:
19 1/2"H x 43 1/4"W

20 CUBIC FEET

- 662-0-02 (Shown)

Ship Weight: 100 Lbs.
(60 1/8"L x 24"W x 24"H)
Door Opening Measures:
19 1/2"H x 55 1/4"W

IN-BED STORAGE

PACK RAT® DRAWER UNITS

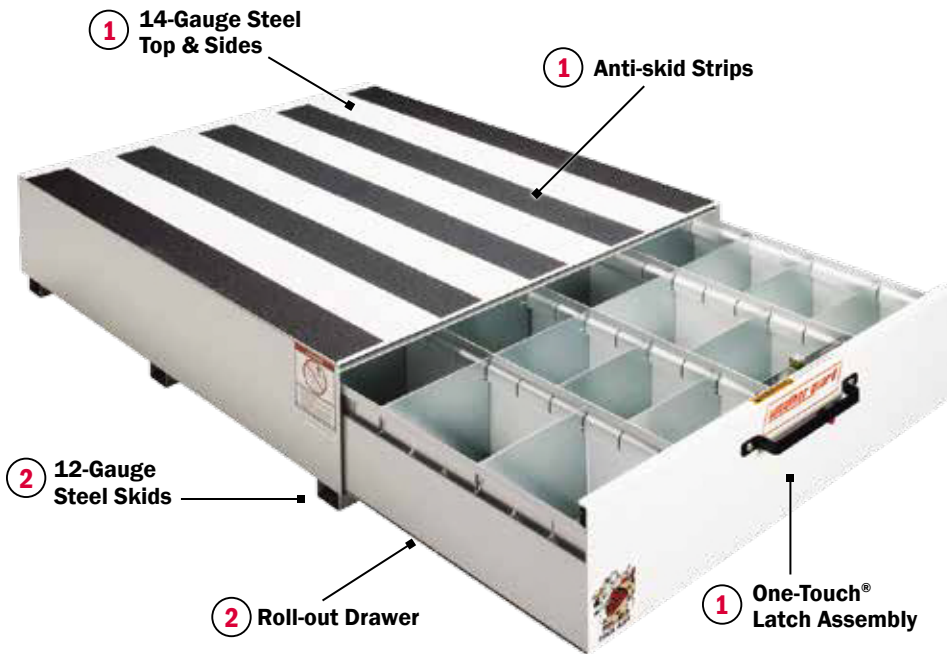

PACK RAT® DRAWER UNIT KEY FEATURES

- 1** 14-Gauge steel top and sides allows 750 lb load rating
- 2** Drawer load rating 425 lbs. evenly distributed
- 3** 12-Gauge steel skids for extra strength
- 4** Anti-skid strips provide traction for workboots
- 5** One-Touch® latch assembly easy, one-hand operation
- 6** Roll-out drawer easy access and organization
- 7** Limited Lifetime Warranty unparalleled quality

LIMITED LIFETIME WARRANTY

HEAVY-DUTY STORAGE KEEPS BED SPACE OPEN AND YOU ORGANIZED

The Heavy-Duty PACK RAT® drawer units can be mounted inside the rear of the vehicle and give you easy access to large tools and supplies while leaving floor space open. These rugged units are constructed of 14-gauge steel on the top and sides, giving you a 750 pound load rating and placing them among the sturdiest items in the back of your truck.

STANDARD DRAWER UNIT 305-3

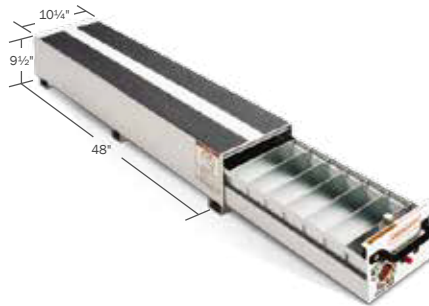

1 COMPARTMENTS, 6 DIVIDERS.

Each Drawer Compartment: 5"H x 9 3/4"W x 45"L

Ship Weight: 106 Lbs.

STANDARD DRAWER UNIT 306-3

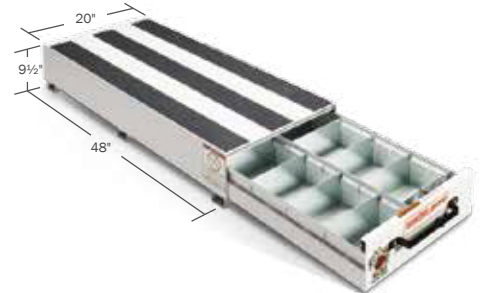

2 COMPARTMENTS, 12 DIVIDERS.

Each Drawer Compartment: 5"H x 9 3/4"W x 45"L

Ship Weight: 179 Lbs.

PACK RAT® DRAWER UNITS

STANDARD DRAWER UNIT

307-3

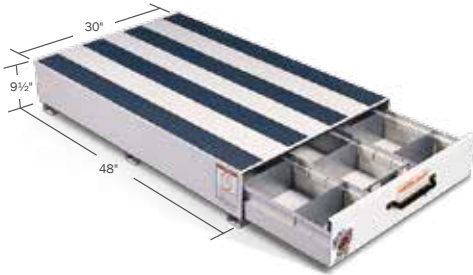

**3 COMPARTMENTS,
18 DIVIDERS.**

Each Drawer Compartment: 5"H x 9 3/4"W x 45"L

Ship Weight: 247 Lbs.

STANDARD DRAWER UNIT

**308-3 (white)
308-5 (black)**



**4 COMPARTMENTS,
24 DIVIDERS.**

Each Drawer Compartment: 5"H x 9 3/4"W x 45"L

Ship Weight: 322 Lbs.

STANDARD DRAWER UNIT

335-3

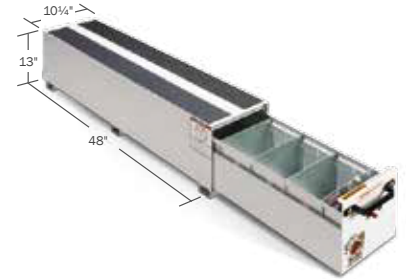

**1 COMPARTMENT,
6 DIVIDERS.**

Each Drawer Compartment: 8 1/2"H x 9 3/4"W x 45"L

Ship Weight: 130 Lbs.

STANDARD DRAWER UNIT

336-3

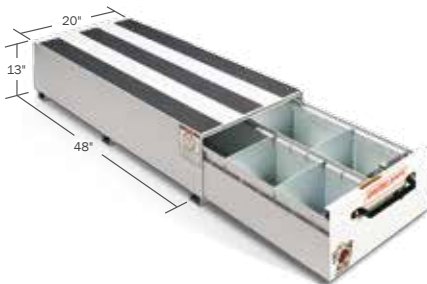

**2 COMPARTMENTS,
12 DIVIDERS.**

Each Drawer Compartment: 8 1/2"H x 9 3/4"W x 45"L

Ship Weight: 210 Lbs.

STANDARD DRAWER UNIT

337-3

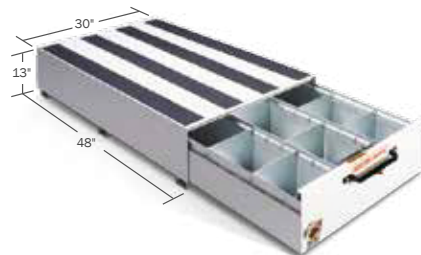

**3 COMPARTMENTS,
18 DIVIDERS.**

Each Drawer Compartment: 8 1/2"H x 9 3/4"W x 45"L

Ship Weight: 294 Lbs.

STANDARD DRAWER UNIT

**338-3 (white)
338-5 (black)**



**4 COMPARTMENTS,
24 DIVIDERS.**

Each Drawer Compartment: 8 1/2"H x 9 3/4"W x 45"L

Ship Weight: 383 Lbs.

IN-BED STORAGE

PACK RAT® DRAWER UNITS

EXTRA-WIDE COMPARTMENT

304-3

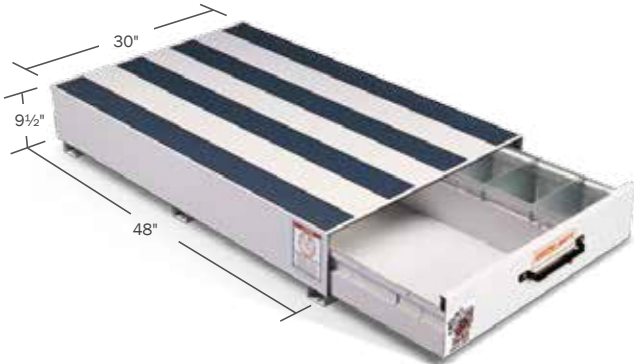

**2 COMPARTMENTS,
6 DIVIDERS.**

Small Compartment: 5"H x 9 3/4"W x 45"L
Large Compartment: 5"H x 19 1/2"W x 45"L

Ship Weight: 220 Lbs.

EXTRA-WIDE COMPARTMENT

334-3

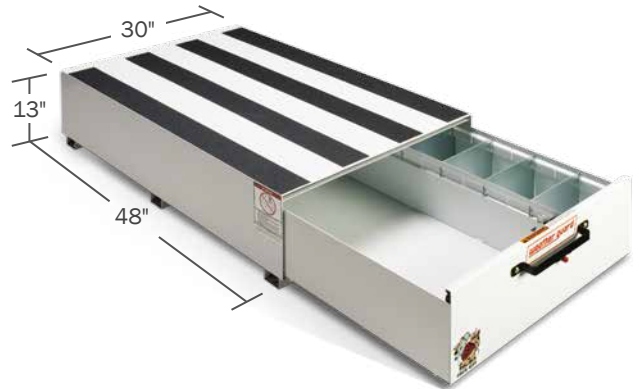

**2 COMPARTMENTS,
6 DIVIDERS.**

Small Compartment: 8 1/2"H x 9 3/4"W x 45"L
Large Compartment: 5"H x 19 1/2"W x 21"L

Ship Weight: 245 Lbs.

SHORT DRAWER UNIT

301-3

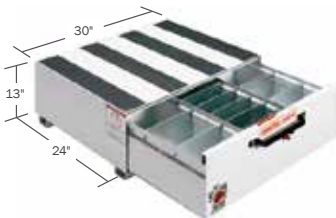

**3 COMPARTMENTS,
12 DIVIDERS.**

Each Drawer Compartment: 8 1/2"H x 9 3/4"W x 21"L

Ship Weight: 169 Lbs.

SHORT DRAWER UNIT

303-3

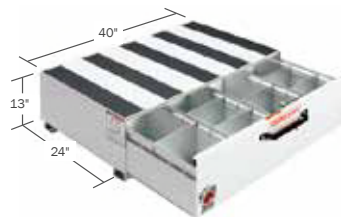

**4 COMPARTMENTS,
12 DIVIDERS.**

Each Drawer Compartment: 8 1/2"H x 9 3/4"W x 21"L

Ship Weight: 217 Lbs.

STANDARD DRAWER UNIT

312-3



**3 COMPARTMENTS,
12 DIVIDERS.**

Each Drawer Compartment: 5"H x 9 3/4"W x 21"L

Ship Weight: 151 Lbs.

DRAWER DIVIDERS 300

DRAWER DIVIDERS 302

BED RAT® SLIDING PLATFORM

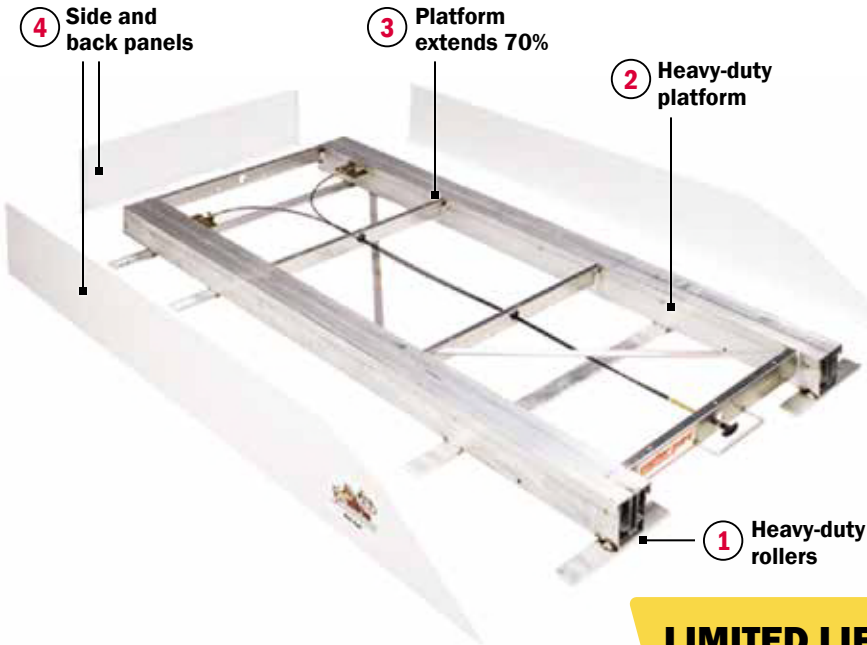

BED RAT® KEY FEATURES

- 1 Heavy duty rollers support maximum loads
- 2 Heavy duty platform supports 750 lbs.
- 3 Platform extends 70% easy access, large work area
- 4 Side and back pack panels keep items from rolling off
- 5 Limited Lifetime Warranty unparalleled quality

LIMITED LIFETIME WARRANTY

GAIN IN EXTRA WORK SPACE FROM THE BED Grabbing tools or parts as you need them during the course of a project is always easier when they're elevated. The BED RAT® Sliding Platform from WEATHER GUARD® works with PACK RAT® Drawer Unit allowing you to pull items toward you from the cargo area, either from the side or rear of the vehicle, creating an additional work space.

BED RAT® SLIDING PLATFORM 3100

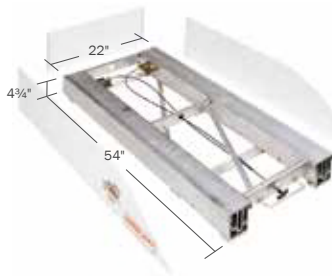

54"L x 22"W x 4¾"H

FITS: Chevy City Express, Express, Colorado, Silverado 1500, Silverado 2500/3500. Dodge Dakota. Ford E-Series, F-150, F-250/F-350, Ranger, Transit, Transit Connect, Transit Connect 2020-2013. GMC Canyon, Savana, Sierra 1500, Sierra 2500/3500. Mercedes Metris, Mercedes Sprinter. Nissan Frontier, Nissan NV, NV200, Titan. Ram 1500, 2500/3500, ProMaster, ProMaster City. Toyota Tundra.

Ship Weight: 107.5 Lbs.

BED RAT® SLIDING PLATFORM 3200

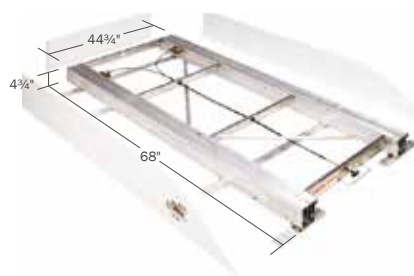

68"L x 44¾"W x 4¾"H

FITS: Chevy City Express, Express, Colorado, Silverado 1500, Silverado 2500/3500. Ford E-Series, F-150, F-250/F-350, Transit. GMC Canyon, Savana, Sierra 1500, Sierra 2500/3500. Mercedes Sprinter. Nissan Frontier, Nissan NV, Nissan Titan. Ram 1500, 2500/3500, ProMaster. Toyota Tundra.

Ship Weight: 144 Lbs.

BED RAT® SLIDING PLATFORM 3400

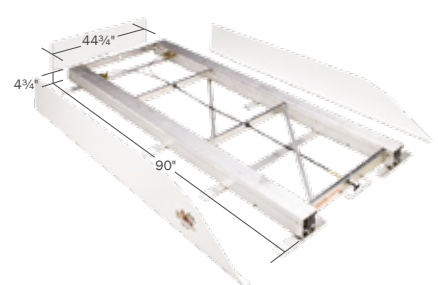

90"L x 44¾"W x 4¾"H

FITS: Chevy City Express, Express, Silverado 1500, Silverado 2500/3500. Ford E-Series, F-150, F-250/F-350, Transit. GMC Savana, Sierra 1500, Sierra 2500/3500. Mercedes Sprinter. Nissan NV, Nissan Titan. Ram 1500, 2500/3500, ProMaster. Toyota Tundra.

Ship Weight: 179.5 Lbs.

IN-BED STORAGE TRANSFER TANKS

1 Vented Filter Cap

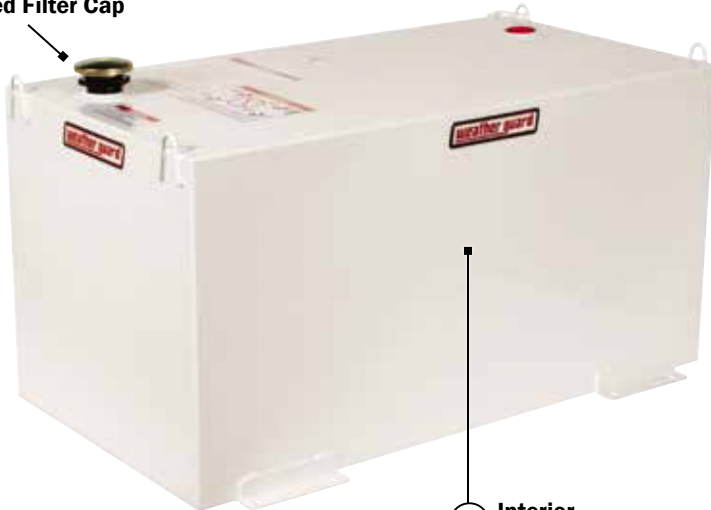

2 Interior Baffle Design

TRANSFER TANK KEY FEATURES

- 1 Vented filler cap prevents excessive pressure build-up
- 2 Interior baffle design reduces fuel movement
- 3 Limited Lifetime Warranty for peace of mind

LIMITED LIFETIME WARRANTY

FOR TRANSPORTING DIESEL FUEL

WEATHER GUARD® Transfer tanks offer a safer mode of transporting diesel fuel to your jobsite and beyond. L-shaped tanks are designed to be used with Cross Boxes and Saddle Boxes only; rectangular tanks are designed for full-size pickup trucks.

Ranging in capacity from 40-110 gallons, WEATHER GUARD® Transfer Tanks feature full arc-welded, heavy 14-gauge steel construction for long-lasting durability. The interior baffle design reduces fuel movement and provides extra tank reinforcement. The lockable vented filler cap prevents excessive pressure build-up

and the threaded filler neck accepts standard 2" threaded pipe. Installation is easy using the heavy-duty lifting loops and secure plate-steel flange bed mounting points. All tanks are protected with Brite White and Gloss Black ARMORTUF® Powder Coat Finish for years of durability, and backed by a Limited Lifetime Warranty.

STEEL TRANSFER TANK 50 GAL. CAPACITY

- 350-3-01
- 350-5-01



For compact pickups. May be used in combination with WEATHER GUARD® Cross and Saddle Boxes.

Ship Weight: 131 Lbs.

STEEL TRANSFER TANK 75 GAL. CAPACITY

- 352-3-01
- 352-5-01



For full-size short-bed pickups. May be used in combination with WEATHER GUARD® Cross and Saddle Boxes.

Ship Weight: 164 Lbs.

TRANSFER TANKS

STEEL TRANSFER TANK 90 GAL. CAPACITY

-  354-3-01
-  354-5-01



For full-size pickups. May be used in combination with WEATHER GUARD® Cross and Saddle Boxes.

Ship Weight: 185 Lbs.

STEEL TRANSFER TANK 40 GAL. CAPACITY



-  351-3-01
-  351-5-01



Lshape design accommodates saddle box.

Ship Weight: 118 Lbs.

STEEL TRANSFER TANK 100 GAL. CAPACITY



-  358-3-01
-  358-5-01



For full-size pickups.

Ship Weight: 152 Lbs.

STEEL TRANSFER TANK 45 GAL. CAPACITY

-  357-3-01
-  357-5-01



Designed for most full-size and compact pickups.

Ship Weight: 94 Lbs.

STEEL TRANSFER TANK 110 GAL. CAPACITY



-  360-3-01
-  360-5-01



For full-size pickups. May be used in combination with WEATHER GUARD® Cross and Saddle Boxes.

Ship Weight: 219 Lbs.

STEEL TRANSFER TANK 50 GAL. CAPACITY

-  359-3-01
-  359-5-01

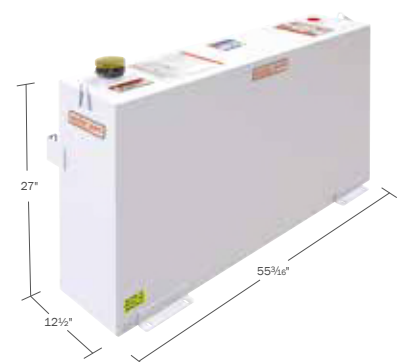

Designed for most full-size pickups.

Ship Weight: 142 Lbs.

STEEL TRUCK RACK



NO-DRILL INSTALL



WELDED AIRFOIL INCLUDED



MAXIMUM TIE DOWN POINTS

- Fits all full size trucks
- 1,000 lb. weight rated – evenly distributed
- Compatible with Weather Guard truck boxes



Tie-Down Points
– 4 per rack



Welded Airfoil

Universal for Full Size Trucks
– front legs adjust based on bed length



Removable Rear Cross Member
– installed with locking pins



Rear Handle Bar
– assist with getting on & off truck



Welded Tie-Down Loops
– 4 per rack



No-Drill Mounting Feet

Matte Black Finish

STEEL TRUCK RACK

FULL SIZE STEEL TRUCK RACK

1275-52-02



COMPACT STEEL TRUCK RACK

1345-52-02

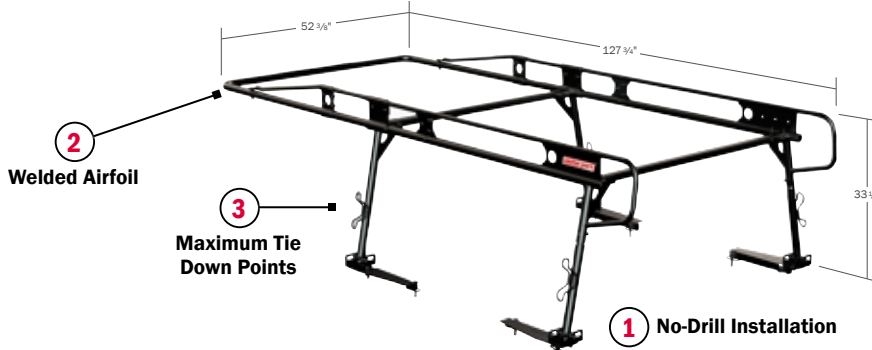

STEEL TRUCK RACK KEY FEATURES

- 1 No-Drill Installation**
Installs in less than an hour (15-20 minutes to assemble /30 minutes to install)
- 2 Welded Airfoil Included**
No need to purchase an accessory, helps deflect wind
- 3 Maximum Tie Down Points**
4 areas allow for additional tie down points on rack legs for items on rack

ACCESSORIES

FULL-SIZE CAB PROTECTOR

1059-52-01

Mounting points line up with pre-drilled holes on Compact Steel Truck Rack Front legs

Matte Black Finish
Matches Compact Steel Truck Rack

Ship Weight: 61 Lbs.

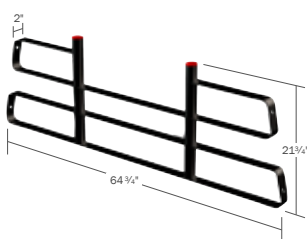

COMPACT CAB PROTECTOR

1058-52-01

Mounting points line up with pre-drilled holes on Compact Steel Truck Rack Front legs

Matte Black Finish
Matches Compact Steel Truck Rack

Ship Weight: 61 Lbs.

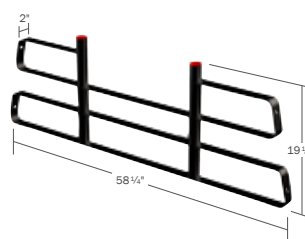

RATCHET STRAPS

1057-52-01

Works with the 1275-52-02 & 1345-52-02 various tie down points

Installation requires product to be drilled into truck rack and is permanently installed to the rack

Quick release button retracts the straps automatically for easy slowing when not in use

Straps rated to 1,000 lbs

INCLUDES:

Set of 2 ratchet straps, mounting bracket, and mounting hardware



FULL-SIZE ACCESSORY CROSS MEMBER

1290-52-01

No-Drill Installation utilizes locking pins (same as rear cross member on rack)

Matte Black Finish
Matches Compact Steel Truck Rack

Ship Weight: 15.5 Lbs.

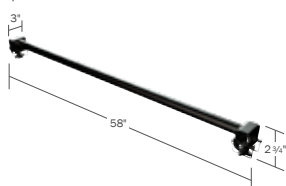

COMPACT ACCESSORY CROSS MEMBER

1390-52-01

No-Drill Installation utilizes locking pins (same as rear cross member on rack)

Matte Black Finish
Matches Compact Steel Truck Rack

Ship Weight: 9.1 Lbs.

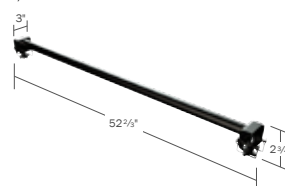

BED-MOUNTED SOLUTIONS

ATR[®] ALUMINUM TRUCK RACK

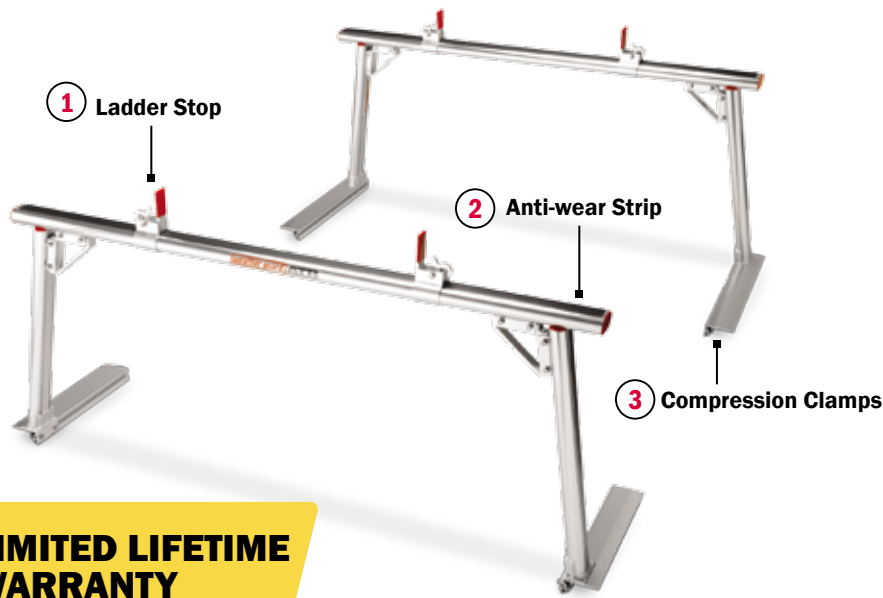

ATR[®] ALUMINUM TRUCK RACK KEY FEATURES

- 1 Ladder stop**
easy to adjust, secures ladder/materials
- 2 Anti-wear strip**
protects ladders and materials
- 3 Compression clamps**
easily secures rack to top of truck bed
- 4 Triple-wall reinforcement**
rigidity, durability
- 5 Limited Lifetime Warranty**
for peace of mind

LIMITED LIFETIME WARRANTY

FOR FULL-SIZE PICKUPS LOAD CAPACITY 800 LBS.



1200

INCLUDES:

4 uprights, 4 mounting bases,
2 cross members, 4 ladder stops

Ship Weight: 68 Lbs.

FOR COMPACT PICKUPS LOAD CAPACITY 800 LBS.



1205

INCLUDES:

4 uprights, 4 mounting bases,
2 cross members, 4 ladder stops

Ship Weight: 61 Lbs.

SECURE TRANSIT AND STORAGE

There are a couple of aspects of security above the truck bed. You need to keep your ladders and equipment secure both in transit and in storage. The WEATHER GUARD[®] ATR (Aluminum Truck Rack) comes in versions that fit either compact or full-size pickups and are constructed with several design extras sure to provide years of secure transit and storage, no matter what your specific needs are.

ACCESSORY SIDE RAILS

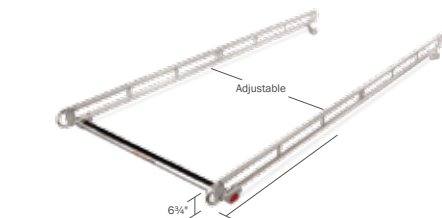

1211

For full-size pickups with 6.5' beds and all compact pickups.

INCLUDES:

2 side rails
1 front cross member

Ship Weight: 46 Lbs.

ACCESSORY SIDE RAILS

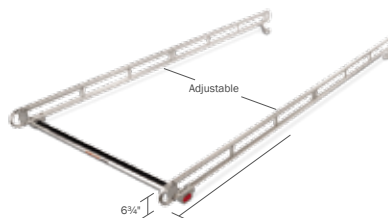

1210

For full-size pickups with 8' beds.

INCLUDES:

2 side rails
1 front cross member

Ship Weight: 52 Lbs.

ACCESSORY CROSS MEMBER



1215

FITS: 1210 and 1211
Accessory Side Rails only.

Ship Weight: 12 Lbs.

ACCESSORY QUICK RELEASE

1218

Allows quick removal of rear cross member (2 each.)

FITS: 1210 and 1211
Accessory Side Rails only.

Ship Weight: 2 Lbs.



STEEL SERVICE BODY RACK

KEY FEATURES

- 1 WEATHER GUARD® Truck Equipment offers the same quality and durability on our Steel Service Body Rack as on our other field-proven racks.

NOTE: Do not mount on aluminum, plastic, fiberglass or top-opening service body trucks: Mount only on steel service bodies.

STEEL SERVICE BODY RACK LOAD CAPACITY 1000 LBS.

1225

For full-size steel service bodies.

INCLUDES: legs, side rails and cross members.

Ship Weight: 233 Lbs.

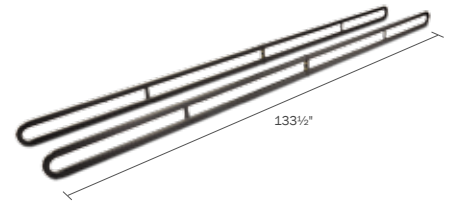

LIMITED LIFETIME WARRANTY

ALUMINUM SERVICE BODY RACK

KEY FEATURES

- 1 The WEATHER GUARD® Aluminum Service Body Rack is designed to make loading or unloading a ladder a "one-person" job.
- 2 Front post adjusts in height and swivels to allow for easy positioning of ladder during removal or placement
- 3 Both posts have a wide mounting

NOTE: Do not mount on an aluminum plastic or fiberglass service body. Mount on steel service body only.

ALUMINUM SERVICE BODY RACK LOAD CAPACITY 200 LBS.

1425-3

For full-size and compact service body trucks on both driver and passenger sides.

Front post adjusts 21³/₁₆"-35³/₁₆"

Rear post is stationary at 21³/₁₆" (shown left)

Front post adjusts 16"-30"

Rear post is stationary at 16¹/₄" (shown right)

Ship Weight: 22 Lbs.

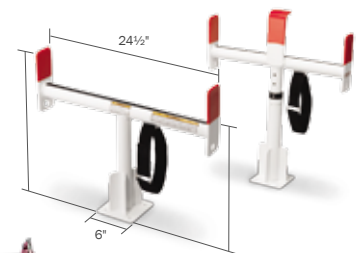

LIMITED LIFETIME WARRANTY

WEEKENDER[®] TRUCK RACK



KEY FEATURES

- 1 Easy on, easy off for that occasional need to carry a ladder or long material.
- 2 Uprights should be removed when not in use.
- 3 Adjustable, tubular steel pockets bolt into the side of the truck bed. A set-screw holds the upright in place.
- 4 Load bar is adjustable to accommodate the varied widths of ladders.
- 5 Constructed of 1½" x 1½", 14-gauge wall steel tubing.
- 6 Joints are fully arc-welded.
- 7 Mounting bracket allows WEEKENDER[®] Truck Rack to be installed on driver side or curb side of truck.
- 8 If installing to an aluminum bed, please purchase the 70322 Aluminum Upfit Kit.

**LIMITED LIFETIME
WARRANTY**



ANGULAR
LOAD CAPACITY 250 LBS.

1475

For '95 and newer pickups,
Chevy, Dodge, Ford and
Toyota Tundra.

Ship Weight: 52 Lbs.



HORIZONTAL
LOAD CAPACITY 250 LBS.

1450

For '95 and newer pickups,
Chevy, Dodge, Ford and
Toyota Tundra.

Ship Weight: 56 Lbs.

PROTECT-A-RAIL® CAB PROTECTORS/ACCESSORIES

FOR COMPACT PICKUPS

1910-3-01 (white)
1910-5-01 (black)

Steel Screen cab protector mounts to the bed of a mini pickup. Installation hardware provided.

1909-3-01 (white)
1909-5-01 (black)

Punched steel screen cab protector. (Requires separate purchase of Installation Kit.)

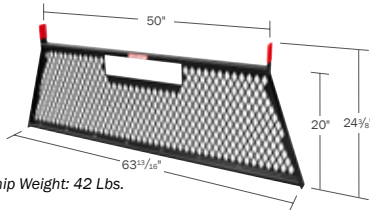
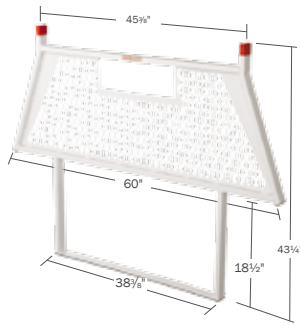

Ship Weight: 42 Lbs.

FOR FULL-SIZE PICKUPS

1905-0-02

Aluminum frame cab protector. Features a lightweight extruded aluminum frame with 14-gauge steel louvers. (Requires separate purchase of Installation Kit.)

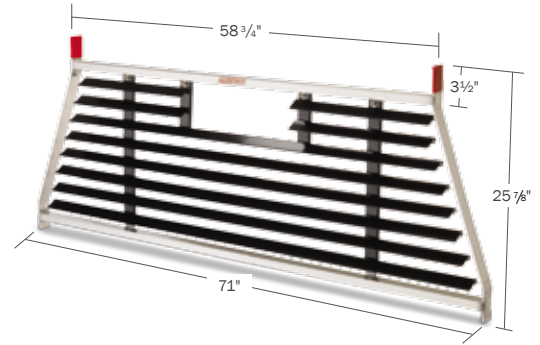

Ship Weight: 33 Lbs.

FOR FULL-SIZE PICKUPS

1907-0-02

Aluminum frame cab protector. Features a lightweight extruded aluminum frame. (Requires separate purchase of Installation Kit.)

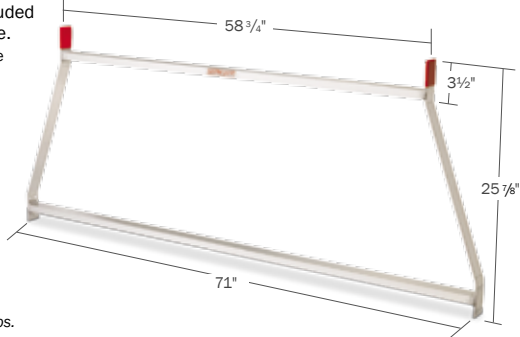

Ship Weight: 19 Lbs.

FOR FULL-SIZE PICKUPS

1904-3-02 (white)
1904-5-02 (black)

Steel louvered cab protector. Features a steel frame and 14-gauge steel louvers. (Requires separate purchase of Installation Kit.)

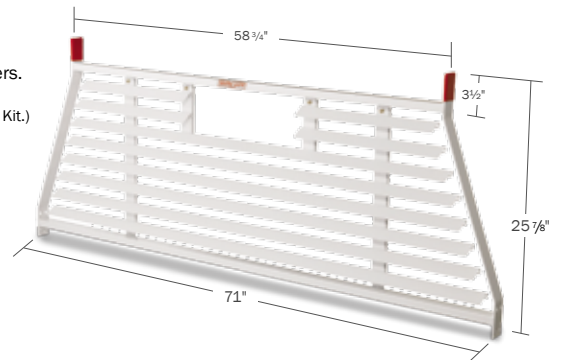

Ship Weight: 46 Lbs.

FOR FULL-SIZE PICKUPS

1906-3-02 (white)
1906-5-02 (black)

Punched steel screen cab protector. (Requires separate purchase of Installation Kit.)

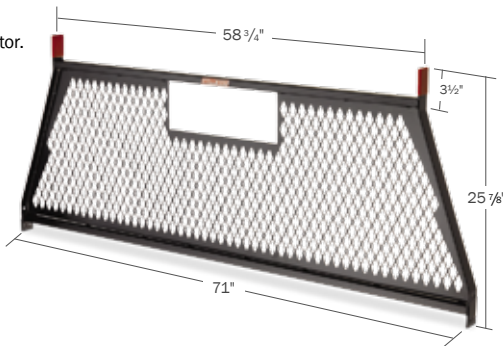

Ship Weight: 33 Lbs.

FOR FULL-SIZE PICKUPS

1908

Heavy-duty cab protector. (Requires separate purchase of Installation Kit.)

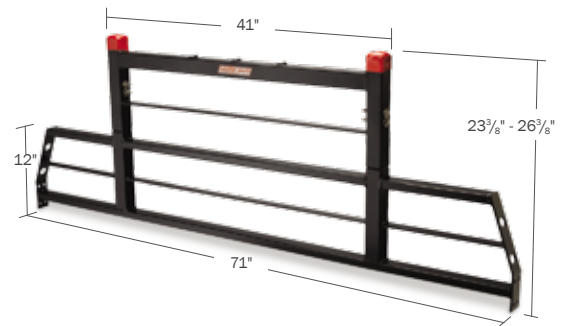

Ship Weight: 46 Lbs.

ACCESSORIES FOR MOUNTING WARNING LIGHTS & LADDERS FOR 1908

1917
Ladder mount extension.
Ship Weight: 5 Lbs.



1918
7½" round base.
Ship Weight: 2 Lbs.



1920
9½" x 17" rectangular base.
Ship Weight: 6 Lbs.



1919
7½" side mount round base.
Ship Weight: 3 Lbs.



INSTALLATION KITS

All full-size & 1909-X-01 PROTECT-A-RAIL® Cab protector models require separate purchase of Installation Kit. Each kit is designed to custom fit your vehicle.

CHEVROLET/GMC

1916-3, 1916-5
'99 and newer Chevy Silverado/
GMC Sierra
Ship Weight: 14 Lbs.

1914-3, 1914-5
'00 and older CK
Ship Weight: 13 Lbs.

1927-3-01, 1927-5-01
'15 and newer Chevy Colorado/
GMC Canyon
Will not fit GM & Chevy 3500 HD.

RAM

1912-3-01, 1912-5-01
'94 and newer
Ship Weight: 13 Lbs.

1921-3-01, 1921-5-01
Crew Cab with short bed

NISSAN

1929-3-01, 1929-5-01
'16 and newer Nissan
Frontier

FORD

1913-3, 1913-5
'97 and newer Ford F-150, 2007 and
newer Toyota Tundra
Ship Weight: 15 Lbs.

1915-3-01, 1915-5-01
'99 to '16 Super Duty F-250/F-350
'96 and older F-150/F-250/F-350
Ship Weight: 14 Lbs.

1925-3-01, 1925-5-01
'17 Super Duty F-250/F-350



Mounting Bracket

ACCESSORY CAB SCREEN FOR FULL-SIZE PICKUPS

1059-52-01
Fits 1275-52-02
Not available for Dodge Dakota and Ford Ranger

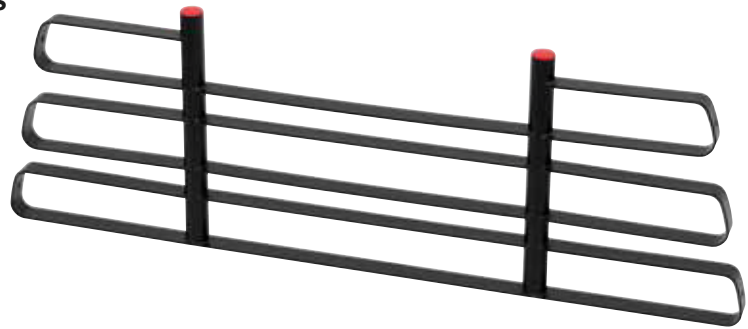

Ship Weight: 61 Lbs.

ACCESSORY CROSS MEMBER



1290-52-01
Fits 1275-52-02 The no-drill accessory cross member allows for shorter items to be placed on top of the rack.

Ship Weight: 15.5 Lbs.

MAKE-YOUR-OWN CONDUIT CARRIER

239
PVC not included. Separately purchase a section of standard 6" PVC (9ASTM D2665) plastic drain pipe. Coordinate the length of the PVC with the length of conduit you'll be carrying.



Ship Weight: 4 Lbs.

ALUMINUM CONDUIT CARRIER

Keep your conduit safe, secure and clean with our lightweight and durable Conduit Carrier.

237
Conduit Carrier
Ship Weight: 40 Lbs.

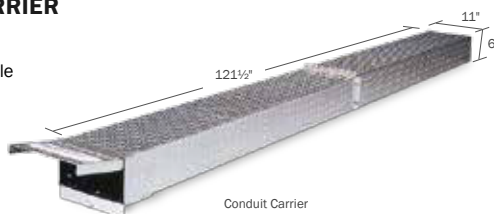

238
6" Extension
Ship Weight: 4 Lbs.



TRUCK RACK UPFIT GUIDE

				TRUCK RACKS				
				1200	1205	1450	1475	1275-52-02
BRAND	MODEL	BED SIZE	BED STYLE	FULL SIZE ATR	COMPACT ATR	WEEKENDER HORIZONTAL RACK	WEEKENDER ANGLED RACK	FULL SIZE STEEL TRUCK RACK
CHEVROLET	COLORADO	5'	FLEETSIDE		•			
CHEVROLET	COLORADO	6'	FLEETSIDE		•	•	•	
CHEVROLET	SILVERADO	5½'	FLEETSIDE	•		• + 70021	• + 70021	•
CHEVROLET	SILVERADO	6'	FLEETSIDE	•		• + 70021	• + 70021	•
CHEVROLET	SILVERADO	8'	FLEETSIDE	•		• + 70021	• + 70021	•
DODGE	DAKOTA	5'	BED		•	•	•	
DODGE	DAKOTA	6½'	BED		•			
RAM	1500/ 2500/ 3500	6'	BED	•		•	•	•
RAM	1500/ 2500/ 3500	8'	BED	•		•	•	•
FORD	RANGER	6'	STYLESIDE		•	•	•	
FORD	RANGER	7'	STYLESIDE		•	•	•	
FORD	F150	5½'	STYLESIDE	•		•	•	•
FORD	F150	6½'	STYLESIDE	•		•	•	•
FORD	F150	6½'	FLARESIDE	•		•	•	•
FORD	F150	8'	STYLESIDE	•		•	•	•
FORD	SUPER DUTY	6½'	STYLESIDE	•		•	•	•
FORD	SUPER DUTY	8'	STYLESIDE	•		•	•	•
FORD 2017 & NEWER	SUPER DUTY	8'	STYLESIDE					•
GMC	CANYON	5'	FLEETSIDE		•			
GMC	CANYON	6'	FLEETSIDE		•			
GMC	SIERRA	5½'	FLEETSIDE	•		• + 70021	• + 70021	•
GMC	SIERRA	6'	FLEETSIDE	•		• + 70021	• + 70021	•
GMC	SIERRA	8'	FLEETSIDE	•		• + 70021	• + 70021	•
TOYOTA	TACOMA	5'	BED		•			
TOYOTA	TACOMA	6'	BED		•			
TOYOTA	TUNDRA	6'	BED	•		•	•	•
TOYOTA	TUNDRA	8'	BED	•		•	•	•
NISSAN	FRONTIER	4½'	BED		•			
NISSAN	FRONTIER	6'	BED		•			
NISSAN	TITAN	5½'	BED	•				•
NISSAN	TITAN	6½'	BED	•				•

CONFIGURATIONS GUIDE



FULL SIZE CONTRACTOR UPFIT

LO-SIDE BOXES (2)

174-0-01 (page 11)

ATR®

1200 (page 30), 1210 Rails (page 30)

PACK RAT®

338-3 (page 25)

SADDLE BOX

127-0-02 (page 5)



STEEL TRUCK RACK UPFIT

STEEL TRUCK RACK

1275-52-02 (page 30)

SADDLE BOX

127-52-02 (page 5)

CAB PROTECTOR

1059-52-01 (page 36)



TRANSFER TANK UPFIT

PROTECT-A-RAIL®

1908 (page 35)

TRANSFER TANK

354-3-01 (page 29)

SADDLE BOX

126-3-02 (page 5)

REPLACEMENT PARTS

LOCKS

7838-2PK – EXTREME PROTECTION® Retrofit Lock Kit

Dual Locks fit current and retro fit older Cross, Saddle, Lo-Side, Pork Chop Boxes

7748-1PK – EXTREME PROTECTION® Replacement Lock Kit

Single Lock for Current Cross, Saddle, Lo-Side, Pork chop & All-Purpose Chests



7081-1PK – Paddle-Handle Latch & Lock Kit

FITS: Older Hi-Sides, current aluminum Underbeds, older steel Underbeds

7106-1PK – Striker Plate Kit

FITS: Three generations Cross, Saddle, Lo-Side, Pork Chop, All-Purpose Chests



CABLES

7069-2PK – 14" Cables

FITS: All standard-size steel and aluminum Hi-Sides

7071-2PK – 16" Cables

FITS: All steel & Aluminum Super-Side Boxes except 297-3 Jumbo Super-Side. Any 18" high Underbeds, current aluminum and old-style steel



PAINT

886-1CN – White Aerosol Touch-up paint

For touchup on all WEATHER GUARD® White Products

887-1CN – Black Aerosol Touch-up paint

For touchup on all WEATHER GUARD® Black Products



BLIND FASTENERS

7998-20PK – ¼" Blind Fasteners (20)

Rigid fastening on sheet metal, fiberglass and plastic

999-20PK – ⅜" Blind Fasteners (20)

Rigid fastening on sheet metal, fiberglass and plastic

7998-10PK – ¼" Blind Fasteners (10)

Rigid fastening on sheet metal, fiberglass and plastic

999-10PK – ⅜" Blind Fasteners (10)

Rigid fastening on sheet metal, fiberglass and plastic



FILL CAP

355-1PK – Fill Cap

FITS: Transfer Tanks



GAS SPRINGS 2PK



7009-2PK

FITS: 121-X-01, 123-X-01, 123, 123-X, 127-X-01, 127, 127-X, R-127, 131-X-01, 137-X-01, 137, 137-X, 147-X-01, 154-X-01, 6212-5.

7249-2PK

FITS: 117-X-01, 117, 117-X, R-117, 126-X-01, 126-X, R-126, 128-X-01, 128-X.

7917-2PK

FITS: 114-X-01, 114, 114-X, 114-B, 124-X-01, 124, 124-X, 124-B, 134, 134-X, 134-B, 153, 153-X, 153-B, 159, 159-X, 159-B, 191, 193.

900-2PK

FITS: 125-X-01, 125-X, R-125, R-125-B, 135-X, R-135, 155-X, R-155.

7095-2PK

FITS: 160-X-01, 161-X-01, 164-X-01, 165-X-01, 166-X-01, 170-X-01, 170, 170-X, 171-X-01, 171, 171-X, 172-X-01, 172, 172-X, 173-X-01, 173, 173-X, 174-X-01, 175-X-01, 184-X-01, 185-X-01, 186-X-01, 644-X-01, 645-X-01, 654-X-01, 654, 654-X, 654-B, 655-X-01, 664-X-01, 664-X, 664, 664-B, 674-X-01, 674-X, 674, 674-B, 675-X-01.

7096-2PK

FITS: 162-X-01, 163-X-01, 166-X-01, 665-X-01, 665-X, 665, 665-B.

7248-2PK

FITS: 116-3, 116-5, R-116.

7250-2PK

FITS: 136-X-01, 136-X, R-136, 156-X-01, 156-X, R-156.

7250-2PK

FITS: 116-X-01, 158-X, R-158.

7252-2PK

FITS: 154, 154-X, R-154.

7900-2PK

FITS: 115-X-01, 115-X, R-115, 157-X, R-157.

7902-2PK

FITS: 165-X-01, 176-X-01, 655, 655-X, 675, 675-X, 684-X-01, 684, 684-X.

7904-2PK

FITS: 685-X-01, 685-X.

918-2PK

FITS: 162-X, 162, 163-X, 163.

932-2PK

FITS: 165-X, 186-X, 630, 630-X.

932-2PK

FITS: 160-X, 160, 161-X, 161, 164, 164-X, R-164, R-164-B, 175-X, 185-X, 624, 624-X.

7010-2PK

FITS: 174, 174-X, R-174, R-174-B, 184, R-184, R-184-B.

7011-2PK

FITS: 176-X.

7901-2PK

FITS: 166-X.

921-4PK – Ball Studs 4-Pack

Fits all KNAACK® & WEATHER GUARD® Gas Springs



*Model Number
Color Coating:
X = 0 (Clear), 3
(White), 5 (Black)



INDUSTRY-LEADING SECURITY

Industry-Leading Security

UNMATCHED DURABILITY AND RELIABILITY

Unmatched Durability and Reliability

MAXIMUM ORGANIZATION AND PRODUCTIVITY

Maximum Organization and Productivity



LIMITED LIFETIME WARRANTY

Knaack LLC (the Manufacturer) warrants to the original purchaser, only, that WEATHER GUARD® truck products (the "WEATHER GUARD Product") will be free from defects in material and workmanship from the date of purchase and continuing for the expected lifetime of the WEATHER GUARD Product. This warranty applies to all WEATHER GUARD product except E-LINE® Products, which have a 10-year warranty. Please call our customer service department toll free at 1.800.456.7865 with any questions or comments.

DO NOT use these products for storing or transporting flammables, explosives, hazardous materials or waste, such as gasoline, solvents, gun powder, dynamite, gases or any tanks, torches or gas powered equipment. These products are intended and safe for storing and transporting small tools and other non-combustible, non-flammable materials. Any modification made to, or unintended use of, these products may create a dangerous condition causing death, serious bodily injury or property damage.

NOTICE

Any modification or unintended use of these products shall immediately void all manufacturers warranties. Manufacturer disclaims all liability for injuries to persons or property resulting from any modification to, or unintended use of these products.

For U.S. Terms and Conditions of Sale please reference form number 78-1117. For Canada Terms and Conditions of Sale please reference form number 78-1145.

For more information:

US – visit weatherguard.com or call 800.456.7865

CANADA – visit weatherguard.ca or call 888.562.2251

