

TIE DOWN

MANUFACTURING INGENUITY



2018 - 2019

RESIDENTIAL ROOFING

INGENUITY

Hatched in a garage in 1969, Tie Down is now one of the most prolific and ingenious on-demand contract manufacturers in the nation, earning more than 60 patents and producing more than 5,500 products. Thousands of companies rely on its proprietary methodology -- The Tie Down Ethos -- to turn back-of-the napkin ideas into functional and quality products across a range of industries. Undaunted and unafraid of any obstacle, Tie Down's expertise quickly drives value into the market. With an array of unprecedented capital equipment housed in more than seven hundred thousand square feet of manufacturing space, Tie Down stands ready to solve the thorniest of problems with ingenuity, skill and care. Once a Tie Down customer, always a Tie Down customer.



RESIDENTIAL PRODUCTS

TOOLS

Shingle Shaper	4
Ladder Hooks	4
Hoisting Wheels	4

GUARDRAILS

Steep Slope Guardrail	11
Rake Edge Bracket	11

WEDGIE PADS

Super Wedgie	5
Wedgie	5
Wedgie Pad & Wedgie Pad Jr.	5

ROOFUMBRELLA

RoofUmbrella®	12
RoofUmbrella® Components	13

STABILIZERS

Ladder Stabilizers	6
Corner Stabilizer	6
Ladder and Hoist Anchor	6

ROOFING HOIST

TP250 Platform Hoist	14
TP250 Advantages	15
TP400 Platform Hoist	16
Engines for TP Series Hoist	17
Solar/Plywood Panel Saddle Carriage	18
Secondary Handle Kit	18
Stand-off Stabilizer	18
Telescopic Support Brace	18
Replacement Hoist Parts	19

SCOOPS & FORKS

Coal Shovel	7
Coal Scoop	7
Roofers Pitch Fork	7

SHINGLE REMOVERS

Shingle Removers	8
Roof Rippers	8
Spud Bars	9
Stripzilla Shingle Removers	9
Ergo Stripper	10
Roofers Spades	10

WALL JACKS

Wall Jacks	20
Wall Jack Specifications	21
Adjustable Wall Brace	21
Replacement Parts	22

SHINGLE SHAPER

Lightweight shingle cutter with handle for easy transport. Cut and rip asphalt/fiberglass shingles. Also includes angle meter on table for valley and hip cuts. **1 per master carton**

Shingle Shaper Part ID: **13806**
Replacement Blade Part ID: **13807**

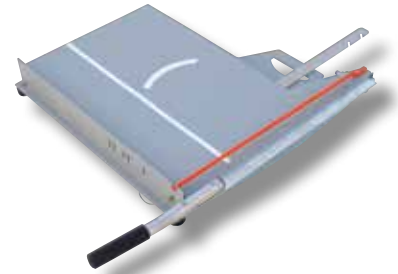

LADDER HOOKS

Quickly and safely access steep roofs. Attaches to the top two rungs of any ladder or extension ladder. Simply roll/slide the ladder past the roof peak and turn over, the hook secures to the opposite side of the roof peak. Features: Rubber Grip T-bar to prevent damage to shingles and metal roofs; yellow zinc plated steel for longer life. Two ladder hooks recommended for each ladder. **8 per master carton**

Hook with Wheel Part ID: **65005**
Hook without Wheel Part ID: **65013**



HOISTING WHEEL

Long handle hoisting wheel designed for raising job site materials using any extension ladder. Comes with locking pins. Accommodates 1/2 in. to 1 in. rope (not included). Handle extends 26 in. and wheel is 12 in. in diameter. **2 per master carton**

Part ID: **13804**



HOISTING WHEEL

Same wheel as the long handle, but no locking pins or handle. Ideal for use on a scaffold platform; outrigger for scaffold not included. **4 per master carton**

Part ID: **13801**



SUPER WEDGIE

Pre-galvanized 16-gauge steel tray that prevents rust. Formed skid plate for easy movement on roof while installing shingles. Foam pad bottom prevents sliding and damage to shingles. Comes with one convenient hand grip. 40 in. long x 14.5 in. wide. Made in the U.S.A.
1 per master carton

Part ID: **48576**



WEDGIE

The TranzSporter Wedgie prevents shingles from slipping off roofs during installation. 7 in. x 7 in. wide. Made in the U.S.A.
10 per master carton.

Part ID: **48579**



WEDGIE PAD & WEDGIE PAD JR.

Reduces damage to shingles during installation along with providing comfort while insulating roofer from excessive heat. For use on asphalt shingles only. Made in the U.S.A.
1 per master carton

Wedgie Pad Jr.	12-1/2 in. x 34 in.	Part ID: 48578
Wedgie Pad	23 in. x 34 in.	Part ID: 48577



STABILIZERS



LADDER STABILIZER

Fixed 48 in. span with 12 in. stand-off. Desirable 12 in. stand-off is ideal for roofing, painting, and siding. Made in the U.S.A.
1 per carton

Part ID: **65025**

Replacement End Caps

2 per pack (**5 pair per master carton**) Part ID: **65026**



LADDER STABILIZER

Helps prevent costly gutter damage when placed directly on roof. The Ladder Stabilizer may be used with standard extension ladders for greater stability and safety. Assembly required. **4 per master carton**

Part ID: **48589**



CORNER STABILIZER

Provides stability when working on corners and may also be used on flat surfaces. Fits aluminum ladders of all duty ratings. Stand-off is 18 in. on flat surfaces. Made with lightweight aluminum. Made in the U.S.A. **1 per carton**

Part ID: **48586**

Replacement End Caps

2 per pack (**5 pair per master carton**) Part ID: **65026**



LADDER & HOIST ANCHOR

Improve job site safety by securing extension ladders and TranzSporter track sections using the Roof Zone Ladder Anchor. Prevents extension ladders and track sections from lateral or side to side movement. Packed 2 straps per package. **36 per master carton**

Part ID: **13809**



RoofZone™ SCOOPS & FORKS

COAL SHOVEL/SCOOPS

Large steel scoop with fiberglass handle is ideal for removing roofing debris. **6 per master carton**

“D” HANDLE SCOOP

14 in. deep and 13 in. tall, overall length of tool is 36-1/2 in.

Part ID: **13870**

LONG HANDLE SCOOP

14 in. deep and 13 in. tall, overall length of tool is 61 in.

Part ID: **13869**



ROOFERS PITCH FORK

Heavy-duty, strong T- steel handle meets any demanding tear-off job. Tines are 11-1/2 in. long with 7 in. head width. Overall length is 41 in. **6 per master carton**

Part ID: **13871**



SHINGLE REMOVERS **ProfZone**TM

SHINGLE REMOVERS

Rugged steel tear-off tools for the removal of asphalt shingles, cedar shakes, and underlayments. Vinyl grip handle for improved hand comfort. Teeth are heat tempered for longer life. Available in three different sizes to assist with those harder to reach areas and steep roof pitches.

4 per master carton

21-1/2 in. Shingle Remover	Part ID: 13825
47-1/2 in. Shingle Remover	Part ID: 13827
54 in. Shingle Remover	Part ID: 13828



ROOF RIPPERS

Designed to aggressively remove asphalt shingles, cedar shakes, and underlayments with ease. Serrated tempered steel blades allow for efficient nail and shingle removal. Heavy-duty steel handle is oval shaped, allowing better grip during shingle removal. Blade and skid plate are replaceable for longer tool life. Rippers are available in two sizes, making shingle removal a breeze at any roof pitch.

4 per master carton

27.5 in. Model	Part ID: 13830
47.5 in. Model	Part ID: 13831

Replacement Blade, Heel, Nuts and Bolts
6 per master carton Part ID: **13832**



Roof Zone™ SHINGLE REMOVERS

SPUD BARS

Heavy-duty steel tube design. Ideal for removing old roofing, mopped down trouble spots, slag as well as gravel, and eliminating fasteners. Our Spud Bars come with hardened steel, bolt-on blades allowing for easy replacement and longevity. Knob Handle Spud Bar overall length is 54-1/2 in. **6 per master carton**

3-1/2 in. Blade with Knob Handle

Part ID: **13816**

7 in. Blade with Knob Handle

Part ID: **13818**

Replacement Blades

25 per master carton

3-1/2 in.

Part ID: **13819**

7 in.

Part ID: **13820**



Knob Handle

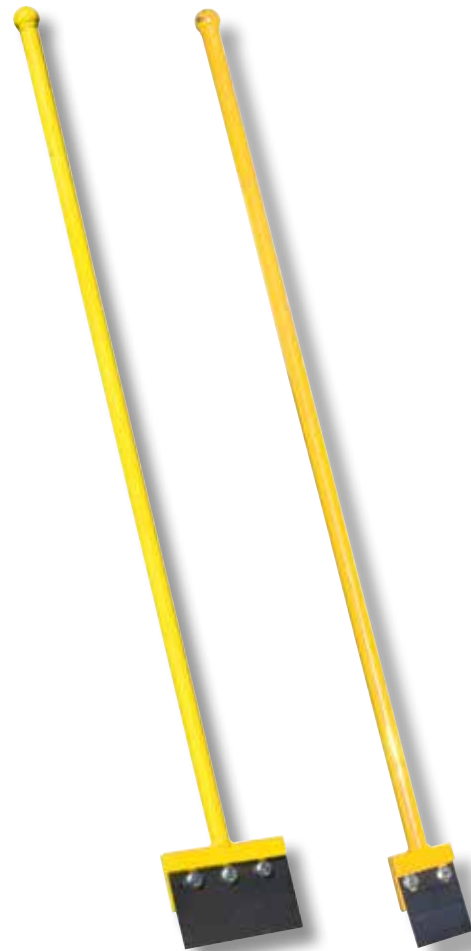

STRIPZILLA SHINGLE REMOVERS

Dual action head for quick shingle and nail removal. Head size is 7 in. x 7 in., made from hi-tensile steel. Made in the U.S.A. **1 per master carton**

D Handle Stripzilla

Part ID: **70619**

Long Handle Stripzilla

Part ID: **70626**



SHINGLE REMOVERS



ERGO STRIPPER

- By placing arm in holster or arm rest, using knees and thighs, your body weight becomes the lever
- 20% faster than traditional tear off tools
- Using an athletic stance* with bent knees 15% and a straight back, it saves your back by decreasing injury
- Ergo Tool works best for contractors 5 ft. to 6 ft.- 6 in. tall

4 per master carton

Part ID: 13880

* An athletic stance is a standing position which allows you to maximize your strength, power, and speed, while decreasing risk of injury. Athletic stance can vary depending on the sport or activity.



ROOFERS SPADES

A favorite with roofers, these tear-off spades have a face size of 7 in. x 11 in. and feature an extra wide heel 6 in. x 9 in. Overall length is 61 in.

6 per master carton

Roofers Spade with wide heel and steel handle (a)
Part ID: 13872

Roofers Spade with wide heel and solid core fiberglass handle (b)
Part ID: 13873

Serrated Roofers Spade with wide heel and steel handle (a,c)
Part ID: 13874

Serrated Roofers Spade with wide heel and solid core fiberglass handle (b,c)
Part ID: 13875



STEEP SLOPE GUARDRAIL

Make your next residential roofing job safer with Roof Zone's Steep Slope Guardrail. Unique design features convenient handle for transporting to the job site. Adjustable rail brackets for easy and fast attachment of 2 x 4's (not included). Lightweight and easy to install. Steep Slope Guardrail bracket has 5 adjustable pitch positions from 4/12 to 16/12, simply remove and tighten wing nut into the corresponding angle and you're done! Extra wing nut and bolt included. Maximum spacing 8 ft. Complies to OSHA standards. Made in the U.S.A.
2 per master carton

Part ID: **65014**



RAKE EDGE BRACKET

For use on all rake edges or eaves with 4/12 pitch or less. Designed to be used with the Roof Zone 65014 Steep Slope Guardrail System. Rake bracket fits under shingle tabs for quick positioning and removal. Key-hole nail openings for 16 in. or 24 in. spacing. Maximum spacing 8 ft. apart. Features toe board openings for proper placement and laser cut pre-galvanized 1.5 in. heavy-duty post with self-locking rail brackets. Complies with OSHA standards. Made in the U.S.A.
2 per master carton

Part ID: **65023**



ROOFUMBRELLA Roof Zone™

THE ONLY ALL-WEATHER ROOF PROTECTION SYSTEM

Our Patented, easy-to-assemble (under 30 minutes) Roof Canopy System will create many new opportunities for you to expand your business, improve the quality of your work, save time, protect your workers and most of all – Make More Money!



RoofUmbrella® benefits include:

- Rain Protection: 40 ft. x 20 ft. waterproof canopy contains a built-in gutter system
- Sun & Heat Protection for Roof, Supplies and Workers: Temperatures can be reduced 30-50 degrees under our canopy
- Overnight Roof Protection: Our canopy can be lowered to ensure the roof and your supplies don't get damaged overnight
- Better Visibility: Lights can easily be added to extend your workday
- Personalized 2 ft. x 6 ft. Banner: Advertising that will be sure to attract attention from all the neighbors
- Built-in OSHA Compliant tie-offs at ladder and ridge



* Patent #9,797,154 and Patents Pending

RoofZone™ ROOFUMBRELLA

ROOFUMBRELLA® COMPONENTS



Center Ridge Base

Center ridge bases are used to support ridge telescoping posts at the center of the ridge. They are hinged to accommodate varying roof slopes. Extension arms insert into center ridge base providing additional canopy tension points. The base also serves as an OSHA compliant tie-off.



Front Torsion Base

Front torsion bases are used to support and adjust front telescoping posts. Bases are attached to joists on the roof edge and secured with fasteners. Bases enable front telescoping posts to pivot allowing for adjustments to canopy tension. Includes ratchet wrench and socket.



Tension Arms

Canopy tension arms connect to any telescoping post and are used to raise the RoofUmbrella® canopy and adjust the tension of the canopy. They're connected to the posts using post pins. The canopy tension arm saddle provides tension adjustment capabilities.



Canopy

The canopy measures 40 ft. x 20 ft., is custom engineered, lightweight, is edged with heavy-duty grommets and has two rain gutters. Using canopy pins, cam straps and bungies the canopy is pinned to the posts and tension is adjusted per installation instructions.



Ladder Dock

The aluminum, diamond-plated ladder dock attaches to the roof to stabilize and tie-off your ladder. It provides a platform at the top of the ladder which makes roof access safer and easier. The tie-off feature meets OSHA Standards.



Custom Advertising Banner

The durable, vinyl banner, which you customize, is displayed between front posts for all to see. Have your company logo, name, phone number or any other information printed on the banner. Use two bungies to easily hang your banner in the most visible location. Additional banners can easily be added to your System.

ROOFING HOIST *TranzSporter*

TP250 PLATFORM HOIST

250 LB. CAPACITY, 28 FT. PLATFORM HOIST

Ideal for moving shingles, felt, insulation, etc. to those hard to reach locations. This hoist features a 25% increase in lifting capacity over previous models, allowing up to 250 lbs. The collapsible carriage comes with a cam bearing engagement system for better tracking and handling. Carriage also features an aluminum deck and flap for lighter weight and longer life. A rolled goods/plywood bracket comes with unit and pins into carriage.

TP250 Base Track Features:

- The 4 ft. heavy-duty aluminum base track utilizes laser cut steel tube support plates for job site toughness.
- Amber carriage bumpers to protect against damage and wear from repeated lowering stops.
- Oversized cotter pins for fast and simple removal of quick change cable drum and belt replacement.
- Large cast aluminum feet for added stability.
- Dual band brake system for positive smoother stops.

TP250 Platform Lift Hoist

28 ft. Hoist with Lifan Gas Engine	Part ID: 60040
28 ft. Hoist with Honda Gas Engine	Part ID: 60041
28 ft. Hoist with Electric Motor	Part ID: 60042

Additional Track Sections

4 ft. TranzSporter Track Section	Part ID: 10092
8 ft. TranzSporter Track Section	Part ID: 10091





















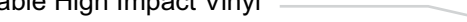



TP250 Shown with Honda Engine

MADE
★IN THE★
USA

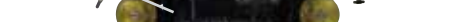
TranzSporte ROOFING HOIST

TP250 ADVANTAGES

Complete Hoist Reach	28 ft.	
Top Cap Pully	Metal	
Cable	5/32 in. Diameter	
Safety Labels	8 on Track in English and Spanish	
Carriage Flap	19 in. x 8-3/4 in.	
Carriage Material	Aluminum for Longer Life	
Carriage Side Guide	Cam Followers on Each Side	
Brake Handle	1-1/4 in. x 1/2 in. Steel, Works on Both Sides	
Brake Handle Length	27 in.	
Carriage Lock	Quick Pin Locking	
Full Coverage Belt Guard	Yes	
Stop Mechanism	Rotatable High Impact Vinyl	
Safety Manual	On Engine - Tube	
Belt Cover Guard	14-5/8 in.	
Base Section	48 in. x 17-1/2 in.	
Motor Weldment	1-1/2 in. Square Tube	
Carriage	14-1/4 in. x 18-1/2 in.	
Plywood Bracket	Quick Pin	
Base Frame Construction	1/8 in. Alum Rail with 3 in. x 1 in. Tubing Reinforced	
Brake Drum	Double	
Cable Drum & Brake Shaft	Zinc plated steel	
Foot Pedal	4-1/4 in. Tread Brite Step	
Foot Pedal Extension	11 in.	
Base Shoe	7-3/8 in. x 2-5/8 in.	

ROOFING HOIST *TranzSporter*

TP400 PLATFORM HOIST

400 LB. CAPACITY, 28 FT. PLATFORM HOIST

For heavier roofing materials, this platform hoist features a 400 lbs. lifting capacity with a lighter weight carriage and revised track system. The TP400 carriage has a 30% reduction in weight over previous model carriage. The aluminum deck and flap provide longer life and lighter weight. This carriage also features a re-engineered and simplified cam bearing track engagement system with less wear parts than former hoists. Rolled goods/plywood brackets come included and pins into carriage.

TP400 Base Track Features:

- The 4 ft. heavy-duty aluminum base track utilizes laser cut steel tube support plates for job site toughness.
- Amber colored carriage bumpers to protect against damage and wear from repeated lowering stops.
- Oversized cotter pins for fast and simple removal of quick change cable drum and belt replacement.
- Large cast aluminum feet for added stability.
- Dual band brake system for positive smoother stops.

TP400 Platform Lift Hoist - 400 lbs. Capacity

28 ft. Hoist with Lifan Gas Engine	Part ID: 60043
28 ft. Hoist with Honda Gas Engine	Part ID: 60044
28 ft. Hoist with Electric Motor	Part ID: 60045

Additional Track Sections

4 ft. TranzSporter Track Section	Part ID: 10092
8 ft. TranzSporter Track Section	Part ID: 10091

MADE
★IN THE★
USA



TP400
Shown with
Honda Engine

TranzSporte ROOFING HOIST

ENGINE & MOTOR OPTIONS

The all new motor base is manufactured using laser cut steel tubing for extra strength and durability. Both belt guard and foot pedal are detailed with aluminum diamond plates. Each engine mount includes a welded on steel instruction tube with red end caps. The instruction tube is clearly labeled; enclosed in the tube is the owner's manual with detailed operating instructions.



4.0 HP LIFAN GAS ENGINE

- Low Oil Shut Down System - Prevents damage to engine due to insufficient oil in engine
- Fuel Shut Off Valve - Protects engine during transportation
- Forced Splash Lubrication System
- Electronic Transistorized Ignition
- Auto Decompression - For easier pull starting
- Overhead Valve - For longer engine life
- Industrial grade components
- Fuel efficient for longer run times
- EPA certified

Lifan Gas Engine with Mount Assembly
Lifan Gas Engine Only

Part ID: **40611L**
Part ID: **12570A**



4.0 HP HONDA GAS ENGINE

- Fuel efficient, high output operation - Overhead valve, precision camshaft design offers precise valve timing and optimal valve overlap
- Smooth performance - Precision engineered components result in lower vibration
- Exceptionally quiet - Large capacity multi-chamber exhaust system
- Proven reliability - Low oil shutdown, cast iron cylinder sleeve, and high quality materials, fit and finish
- CARB and EPA certified

Honda Gas Engine with Mount Assembly
Honda Gas Engine Only

Part ID: **40611H**
Part ID: **10039A**

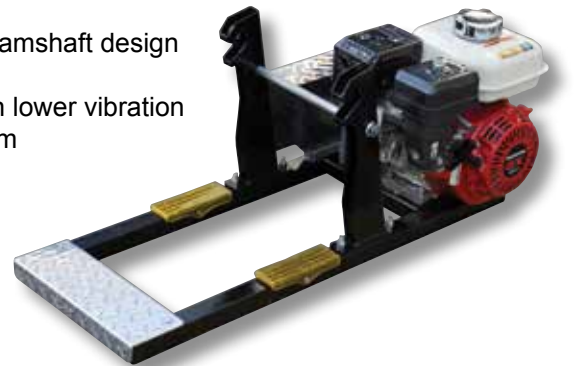

1.0 HP HIGH TORQUE ELECTRIC MOTOR

1.0 hp, 12.8 amps, 115 Volt High Torque Leeson Electric Motor Comes with GFCI ground-fault circuit interrupter for safer operation.

Electric Motor with Motor Base Mount
Electric Motor Only

Part ID: **40611E**
Part ID: **12561A**



ROOFING HOIST *TranzSporter*

HOIST ACCESSORIES

SOLAR/PLYWOOD PANEL SADDLE CARRIAGE

Allows lifting of up to four solar panels or plywood sheets. Unique design allows panels to roll off towards the contractor, preventing leaning while on the roof top. Requires roof top anchoring; straps included (#13809). Both TP250/400 models require a Secondary Handle Kit #48468 when used with Solar/Plywood Brackets (not included). Made in the U.S.A.

TP250 Carriage Part ID: **48469**
TP400 Carriage Part ID: **48467**



SECONDARY HANDLE KIT

Allows use of a left side handle to engage the motor and carriage. Secondary Handle Kit is required when using the Solar/Plywood Saddle Carriage. Highly recommended when lifting plywood sheet and insulation panels. Can be used for both TP250 & TP400 models. Made in the U.S.A.

Part ID: **48468**



STAND-OFF/STABILIZER

This unique stabilizer attaches to the platform hoist track section allowing proper stand-off from roof and gutter. Helps prevent costly gutter damage when placed directly on roof. Assembly required.

Part ID: **48599**



TELESCOPIC SUPPORT BRACE

Used with TP250 & TP400 models over 28 ft. Made in the U.S.A.

Part ID: **60005**

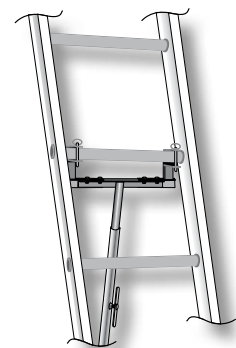

TranzSporte ROOFING HOIST

HOIST REPLACEMENT PARTS

TP250 COMPLETE DRUM ASSEMBLY

Kit Includes: Brake Drums, Cable Drum, Cable and Bearings.

Cable Only - 100 ft. x 5/32 in.
Drive Belt - 51 in. V-Belt

Part ID: **48493A**
Part ID: **90010**
Part ID: **10047**

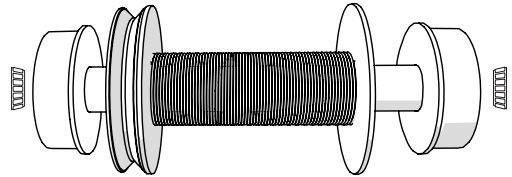

TP400 COMPLETE DRUM ASSEMBLY

Kit Includes: Brake Drums, Cable Drum, Cable and Bearings.

Cable Only - 130 ft. x 3/16 in.
Drive Belt - 51 in. V-Belt

Part ID: **48493A-400**
Part ID: **90034**
Part ID: **10047**

TP250 COMPLETE CARRIAGE WHEEL KIT

Kit Includes: (2) Zinc Bolts, (2) Lock Washers,
(4) Washers & (2) Carriage Wheels.

Part ID: **90040**

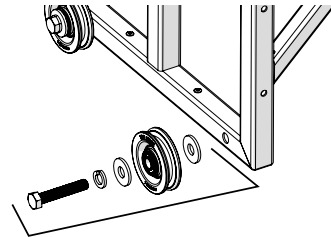

TP400 COMPLETE CARRIAGE WHEEL KIT

Kit Includes: (2) Carriage Bolts, (2) Washers,
(2) Carriage Wheels & (2) Jam Nuts.

Part ID: **90048**

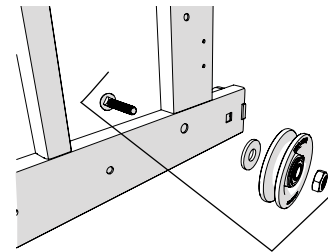

BRAKE KIT

Kit Includes: Lock Nut, Eye Bolt, Spring, (2) Cotter Pins,
Linkage & Brake Strap.

Part ID: **90007**

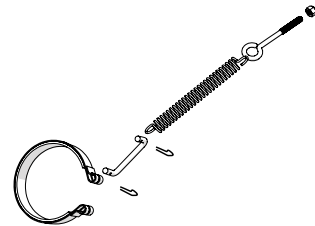

SPLICE PLATE KIT

Kit Includes: (2) Splice Plates, (8) Bolts & (8) Keeper Nuts

Part ID: **90025**

Nuts and Bolts only (16 ea.) Part ID: **90024**

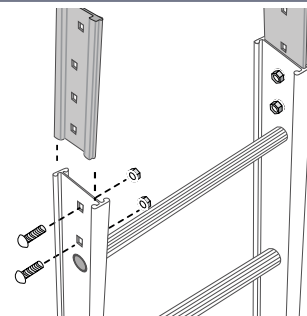

WALL JACKS

TranzSporter

TRANZSPORTER WALL JACKS



A pair of TranzSporter Wall Jacks raise walls in minutes!

The safest way to lift walls. TranzSporter Wall Jacks are designed to safely and efficiently lift preformed walls into a vertical position. Constructed of heavy-duty steel tubing. TranzSporter Wall Jacks are available in 16 ft., 20 ft. and 23 ft. lengths (sold in pairs). After lifting walls, use the TranzSporter Wall Brace to secure the wall in the vertical position. Wall braces are adjustable and sold individually.

- Wall Jacks can safely lift sheathed walls up to 70 ft. long!
- Square tubing is stronger and easier to use than round tube models
- All Wall Jacks are constructed with zinc plated lower tubes and pre-galvanized upper tubing with a clear coat finish
- Replaceable wall jack floor plate, no more costly lower tube replacement
- Spring loaded wall stop with plastic covered handle grip
- Easy replacement of cable assembly and pulley



16 ft. Wall Jack
20 ft. Wall Jack
23 ft. Wall Jack

Part ID: **48581**
Part ID: **48582**
Part ID: **48583**

MADE
★ **IN THE** ★
USA

WALL JACK SPECIFICATIONS

	16 ft.	20 ft.	23 ft.
Extended Length:	16 ft.	20 ft.	23 ft.
Part ID:	48581	48582	48583
Closed Length:	9 ft. - 6 in.	11 ft. - 6 in.	12 ft. - 6 in.
Weight:	50 lbs. each	70 lbs. each	80 lbs. each
Wall Lift:	7 ft. to 10 ft.- 6 in.	8 ft. to 13 ft.- 6 in.	8 ft.-3 in. to 15 ft.- 6 in.
Capacity:	2,000 lbs. per pair	1,000 lbs. per pair	1,000 lbs. per pair

	16 ft.	20 ft.	23 ft.	
Wall Stop Settings (From foot to wall stop)	Wall Height 8 ft. 8 ft.- 3 in. 8 ft.- 6 in. 9 ft. 9 ft. - 6 in. 10 ft. 10 ft. - 6 in.	Stop Height 11 ft.- 7 in. 12 ft. 12 ft.- 3 in. 13 ft. 13 ft.- 9 in. 14 ft.- 6 in. 15 ft.- 2 in.	Wall Height 11 ft. 11 ft.- 6 in. 12 ft. 12 ft.- 6 in. 13 ft. 13 ft.- 6 in.	Stop Height 15 ft.-11 in. 16 ft.- 8 in. 17 ft.- 4 in. 18 ft.- 1 in. 18 ft.-10 in. 19 ft.- 7 in.

	23 ft.
Wall Stop Settings (From foot to wall stop)	Wall Height 13 ft. 13 ft.- 6 in. 14 ft. 14 ft.- 6 in. 15 ft. 15 ft.- 6 in.
	Stop Height 18 ft.- 10 in. 19 ft.- 7 in. 20 ft.- 3 in. 21 ft. 21 ft.- 9 in. 22 ft.- 5 in.

ADJUSTABLE WALL BRACE

Save time and money using TranzSporter Adjustable Wall Brace instead of bracing with lumber. The 10 ft. adjustable brace uses a heavy-duty, 1 in. zinc plated steel square tube. The head has a 12 in. long 3/4 in. diameter fast turn screw; foot has a smooth action 360 degree swiveling bracket with no wobble. Just a few turns of the wrist and the wall is plumb.

Part ID: **48580**

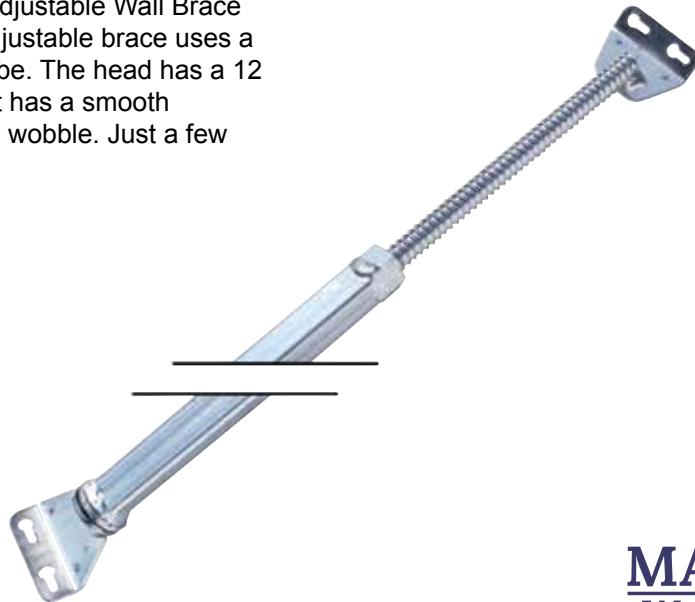

**MADE
★IN THE★
USA**

WALL JACK REPLACEMENT PARTS

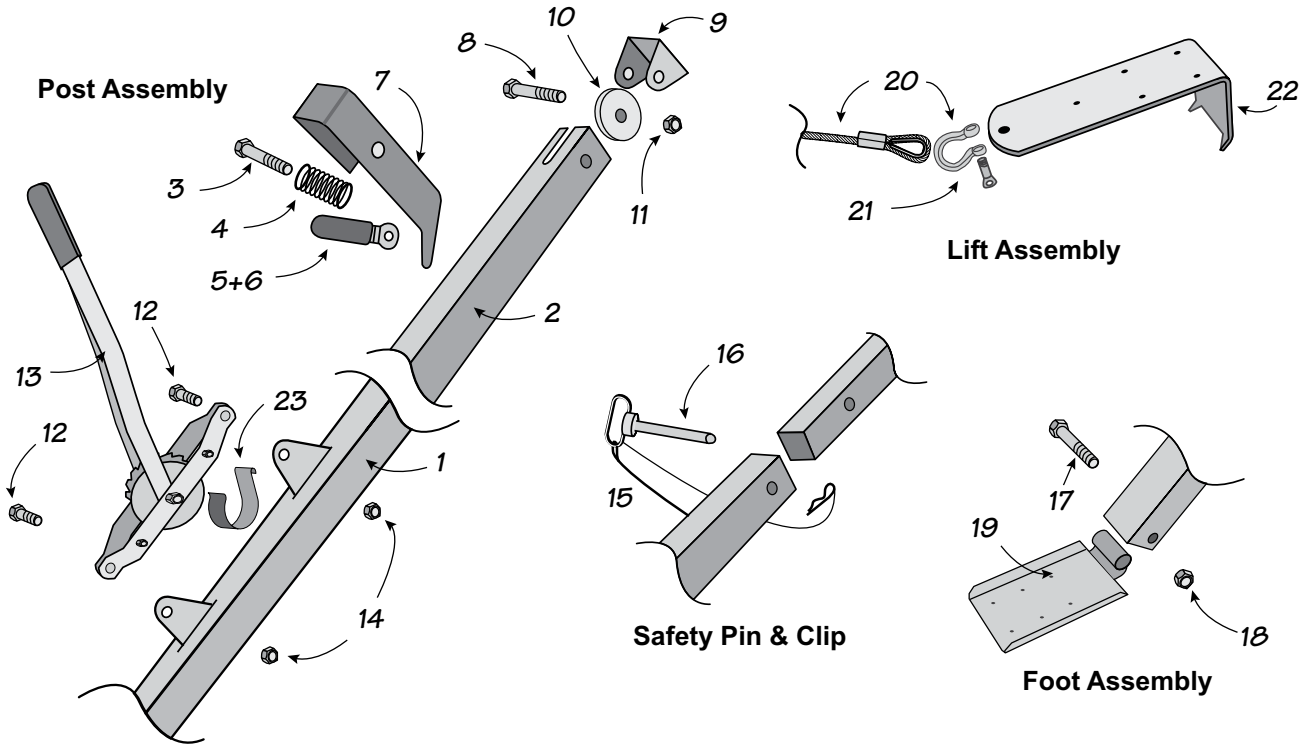

#	Part ID:	Description	#	Part ID:	Description
1	48581-1	16 ft. Lower Tube (excludes foot, pin/chain and winch)	13	17140-1	Winch-same for all models (without cable)
2	48581-2	16 ft. Upper Tube (excludes pulley)	13	17140A1	Complete Winch with Cable & Shackle (#48581)
1	48582-1	20 ft. Lower Tube (excludes foot, pin/chain and winch)	13	17140A2	Complete Winch with Cable & Shackle (#48582)
2	48582-2	20 ft. Upper Tube (excludes pulley)	13	17140A3	Complete Winch with Cable & Shackle (#48583)
1	48583-1	23 ft. Lower Tube (excludes foot, pin/chain and winch)	14	10650	Nut 3/8 in.
2	48583-2	23 ft. Upper Tube (excludes pulley)	15	50389	Safety Pin and Cables
3	10826	1/2 in. x 3 in. Carriage Bolt	16	10592A	Safety Pin (with clip only)
4	10113	Wall Stop Spring	17	10808	Bolt 5/8 in. x 3.5 in.
5	17545	Wall Stop Plastic Handle Cover	18	10628	Nyloc Nut 5/8 in.
6	48581-8	Wall Stop Handle	19	48581-3	Wall Jack Foot
7	48581-7	Adjustable Wall Stop	20	50386	Cable and Shackle for 16 ft.
8	10541	Bolt 1/2 in. x 3 in.	20	50387	Cable and Shackle for 20 ft.
9	48581-9	Top Cap	20	50388	Cable and Shackle for 23 ft.
10	10079	Top Pulley	21	13138	Shackle
11	10645	Nyloc Nut 1/2 in.	22	48581-4	Lifting Wall Bracket
12	10952	Bolt 3/8 in. x 1-1/4 in.	23	10121	Tension Spring for Winch

FALL PROTECTION & SAFETY PRODUCTS

Over the years, Tie Down Engineering has provided a number of innovative fall protection solutions that are manufactured here in the U.S.A. No matter what product we manufacture, our team takes extreme pride in providing products that are easier, safer and more efficient to work with. Led by a team of highly qualified engineers and experienced personnel, we can help solve your unique safety challenges. With a full array of manufacturing resources, our innovation expands beyond the norms of other so called suppliers of fall protection equipment. No one understands working with metal more than those here at Tie Down Engineering. Challenge our team, we embrace it!

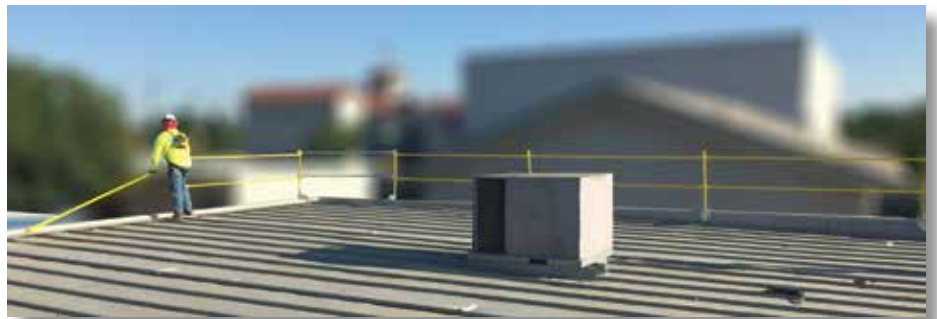



TIE DOWN

MANUFACTURING INGENUITY

Roofing Products Division
Atlanta, Georgia 30336
Toll Free: 800-241-1806
Office: 404-344-0000
www.tiedown.com

ISO 9001:2015 Certification
Intellectual Property of TIE DOWN.
© 2018 TIEDOWN, Inc.
#08297, E1563 (Rev. 10/11/2018)